

L-ION PANEL

NOTLAR :

1-(*) İşaretili giriş/çıkışlar L-ION EP33 modelinde yoktur.

2-Röle çıkışlar 24VAC 5A'dır.



TEL: 0216 527 98 70
FAX: 0216 527 98 71
INTERNET: www.ontrol.com.tr

PROJE
ONTROL A.Ş

SİSTEM
**Senaryo Tip 2
L-ION EP 44**

TARİH 03.09.2009
REV.NO R01
ÇİZEN AYSUN VAYIÇ

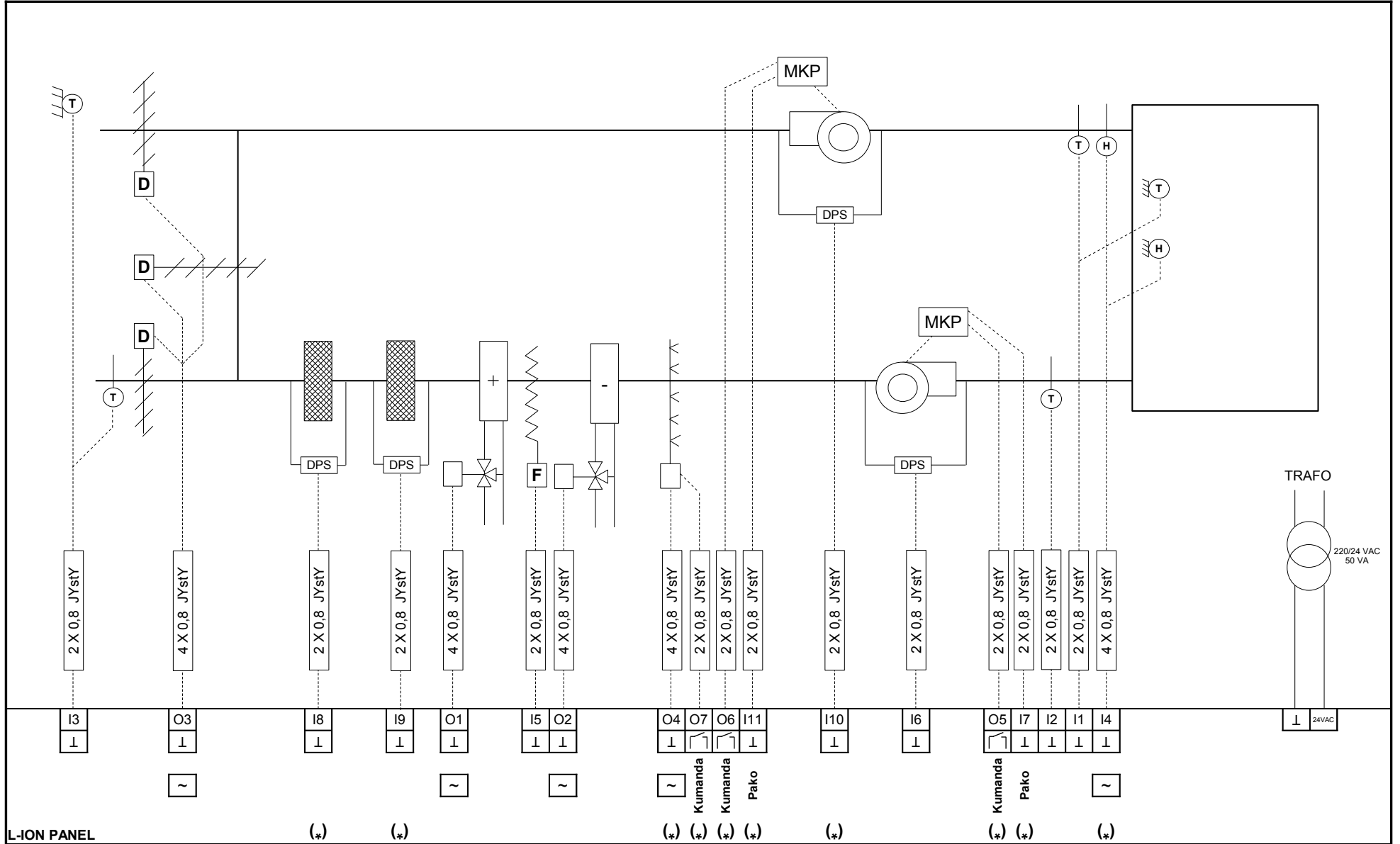

NOTLAR :

1-(*) İşaretili giriş/çıkışlar L-ION EP33 modelinde yoktur.

2-Röle çıkışlar 24VAC 5A'dır.



TEL: 0216 527 98 70
 FAX: 0216 527 98 71
 INTERNET: www.ontrol.com.tr

PROJE
ONTROL A.Ş

SİSTEM
**Senaryo Tip 5
 L-ION EP 44**

TARİH 03.09.2009
 REV.NO R01
 ÇİZEN AYSUN VAYIÇ

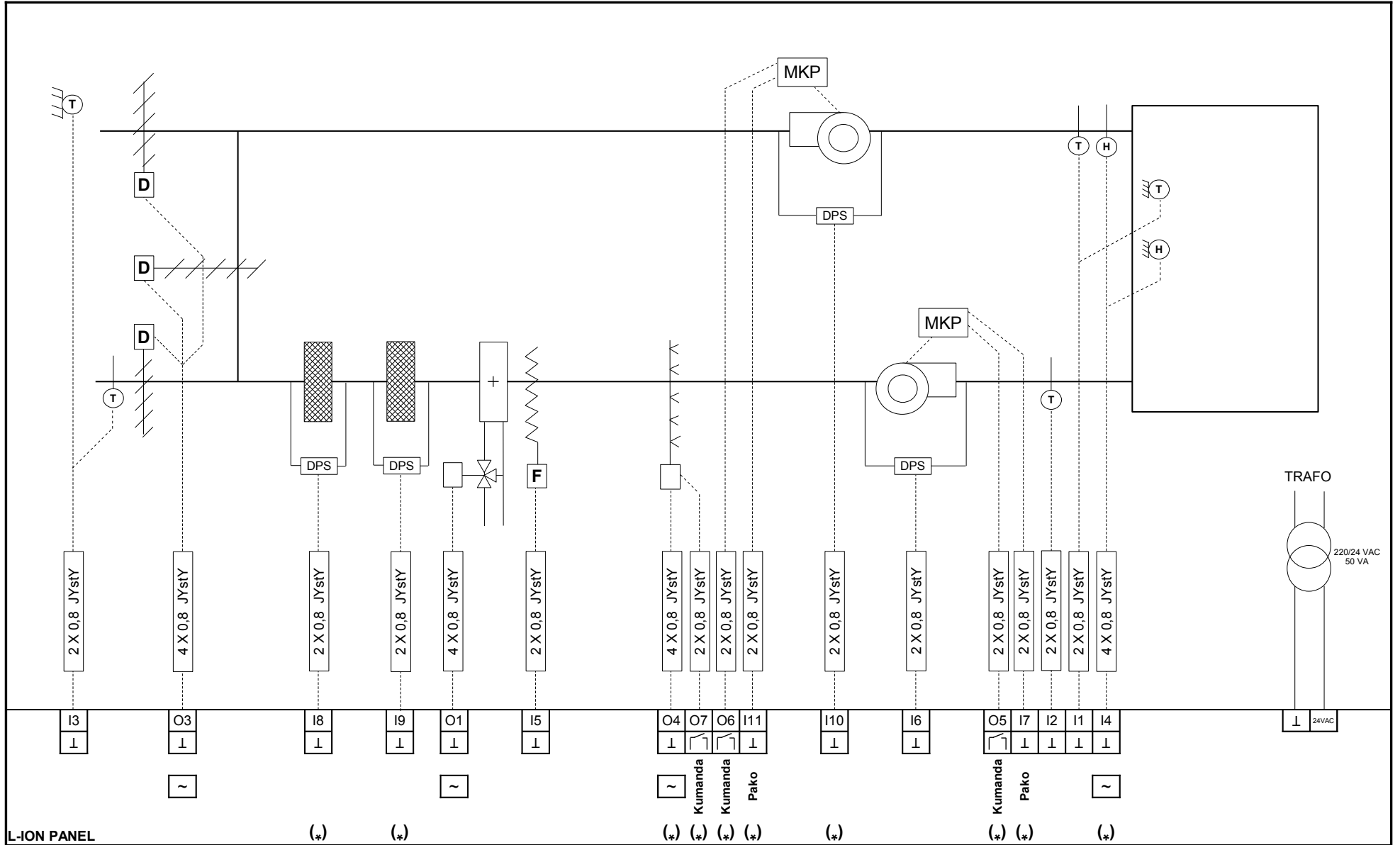

NOTLAR :

1-(*) İşaretili giriş/çıkışlar L-ION EP33 modelinde yoktur.

2-Röle çıkışlar 24VAC 5A'dır.



TEL: 0216 527 98 70
 FAX: 0216 527 98 71
 INTERNET: www.ontrol.com.tr

PROJE **ONTROL A.Ş**

SİSTEM **Senaryo Tip 6
 L-ION EP 44**

TARİH 03.09.2009
 REV.NO R01
 ÇİZEN AYSUN VAYIÇ

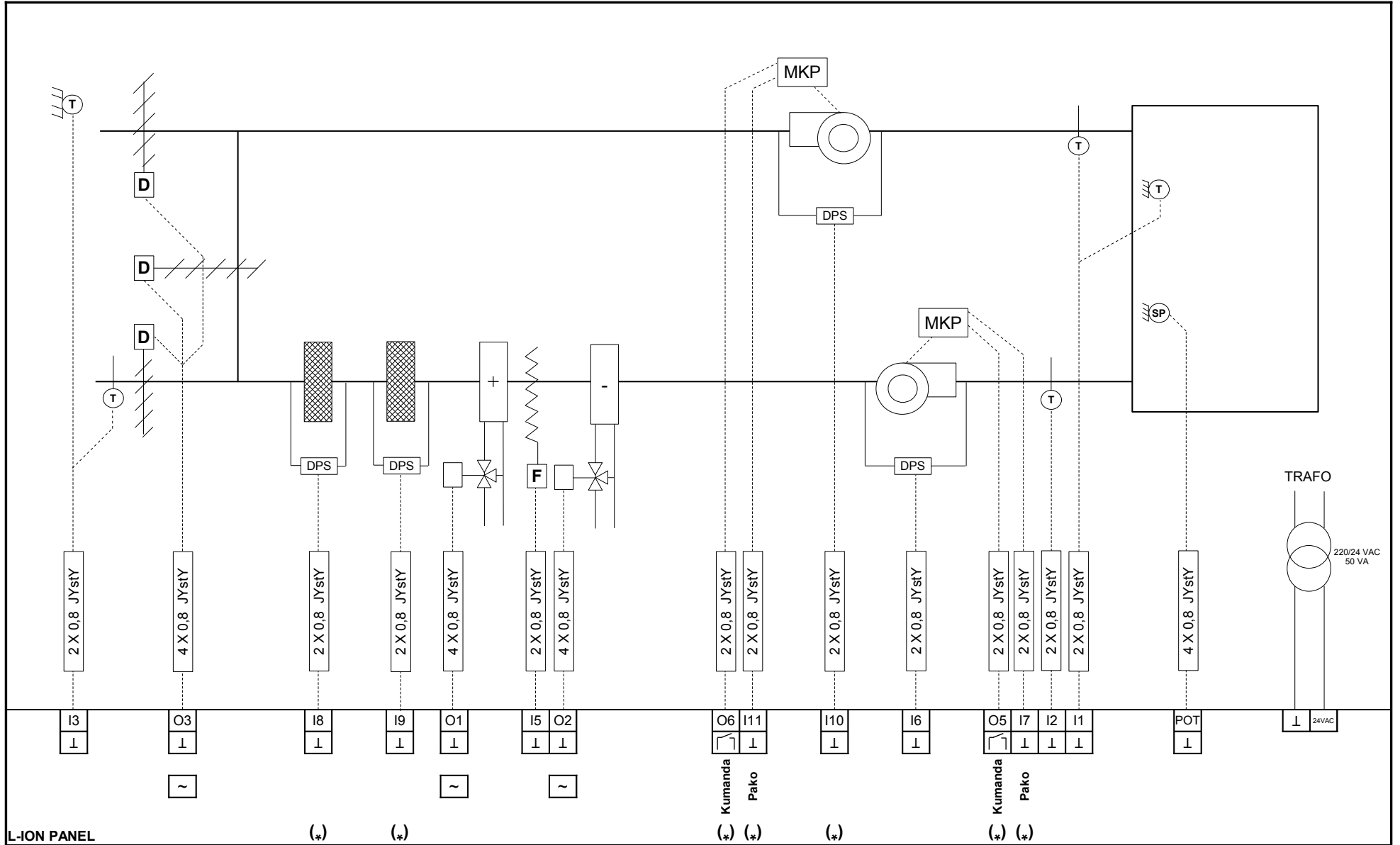

NOTLAR :

1-(*) İşaretili giriş/çıkışlar L-ION EP33 modelinde yoktur.

2-Röle çıkışlar 24VAC 5A'dır.



TEL: 0216 527 98 70
 FAX: 0216 527 98 71
 INTERNET: www.ontrol.com.tr

PROJE **ONTROL A.Ş**

SİSTEM **Senaryo Tip 9
 L-ION EP 44**

TARİH 03.09.2009
 REV.NO R01
 ÇİZEN AYSUN VAYIÇ

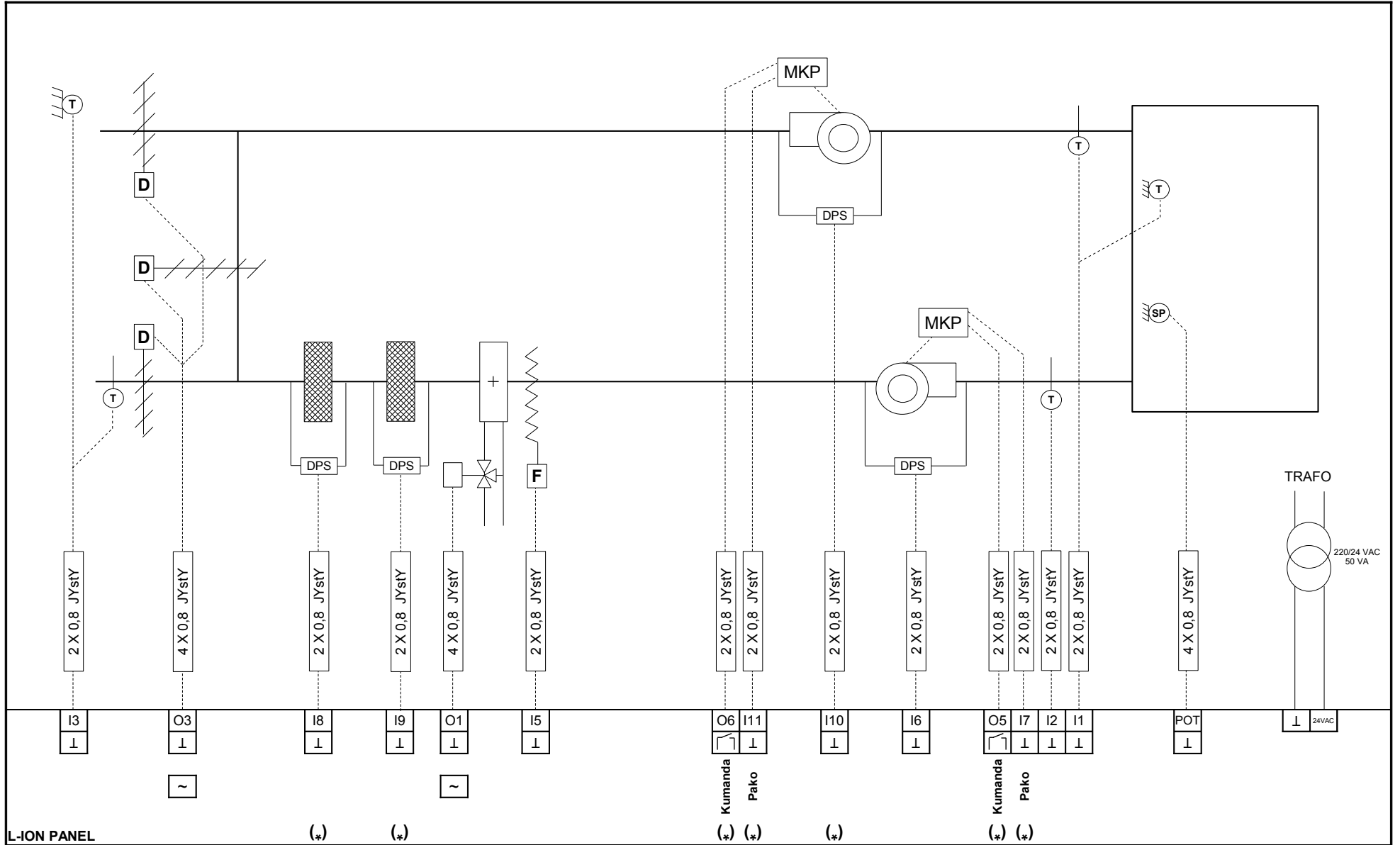

NOTLAR :

1-(*) İşaretili giriş/çıkışlar L-ION EP33 modelinde yoktur.

2-Röle çıkışlar 24VAC 5A'dır.



TEL: 0216 527 98 70
 FAX: 0216 527 98 71
 INTERNET: www.ontrol.com.tr

PROJE **ONTROL A.Ş**

SİSTEM **Senaryo Tip 10
 L-ION EP 44**

TARİH 03.09.2009
 REV.NO R01
 ÇİZEN AYSUN VAYIÇ

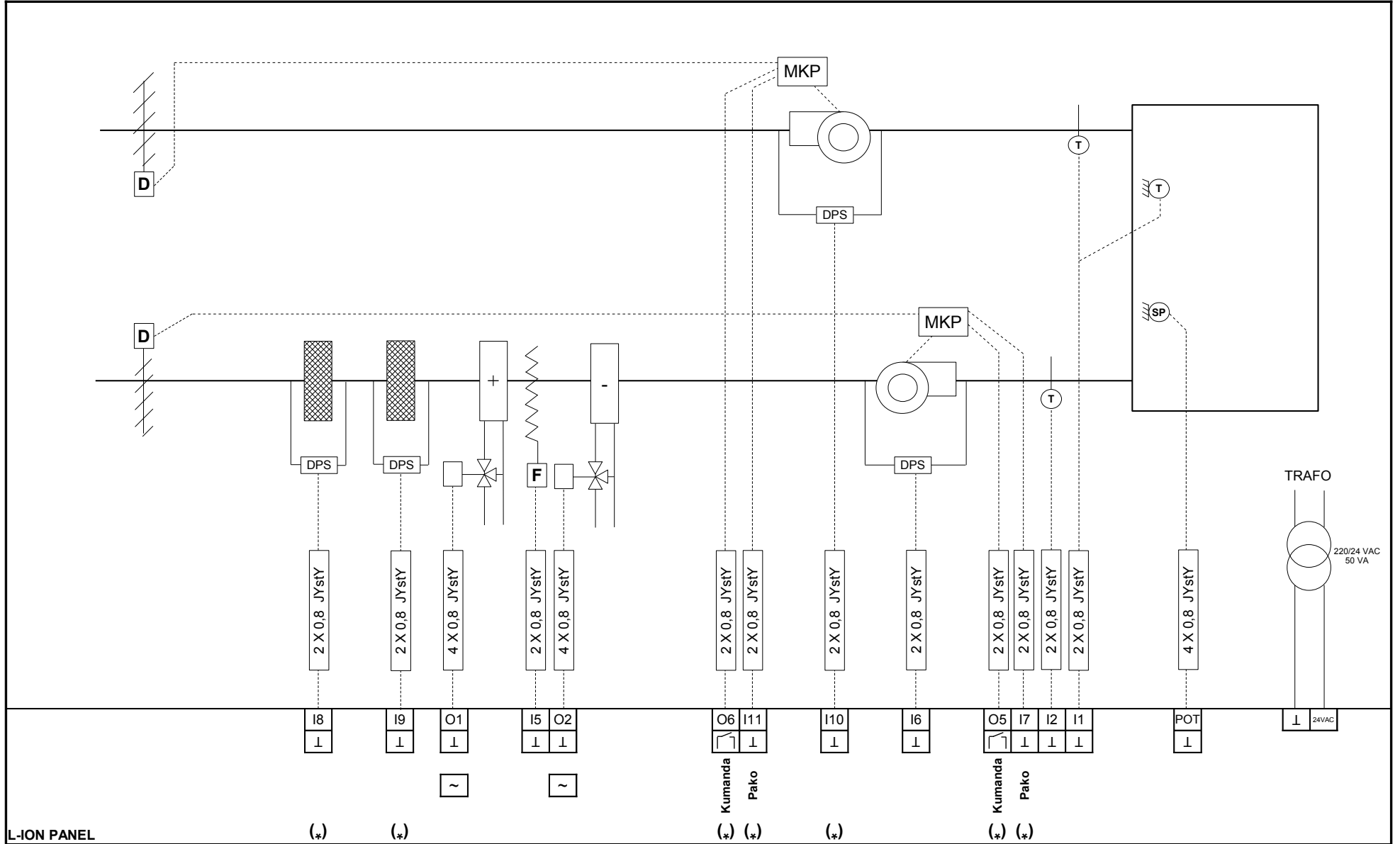

NOTLAR :

1-(*) İşaretili giriş/çıkışlar L-ION EP33 modelinde yoktur.

2-Röle çıkışlar 24VAC 5A'dır.

	TEL: 0216 527 98 70	PROJE ONTROL A.Ş	SİSTEM Senaryo Tip 12 L-ION EP 44	TARİH: 03.09.2009
	FAX: 0216 527 98 71			REV.NO: R01
	INTERNET: www.ontrol.com.tr			ÇİZEN: AYSUN VAYIÇ

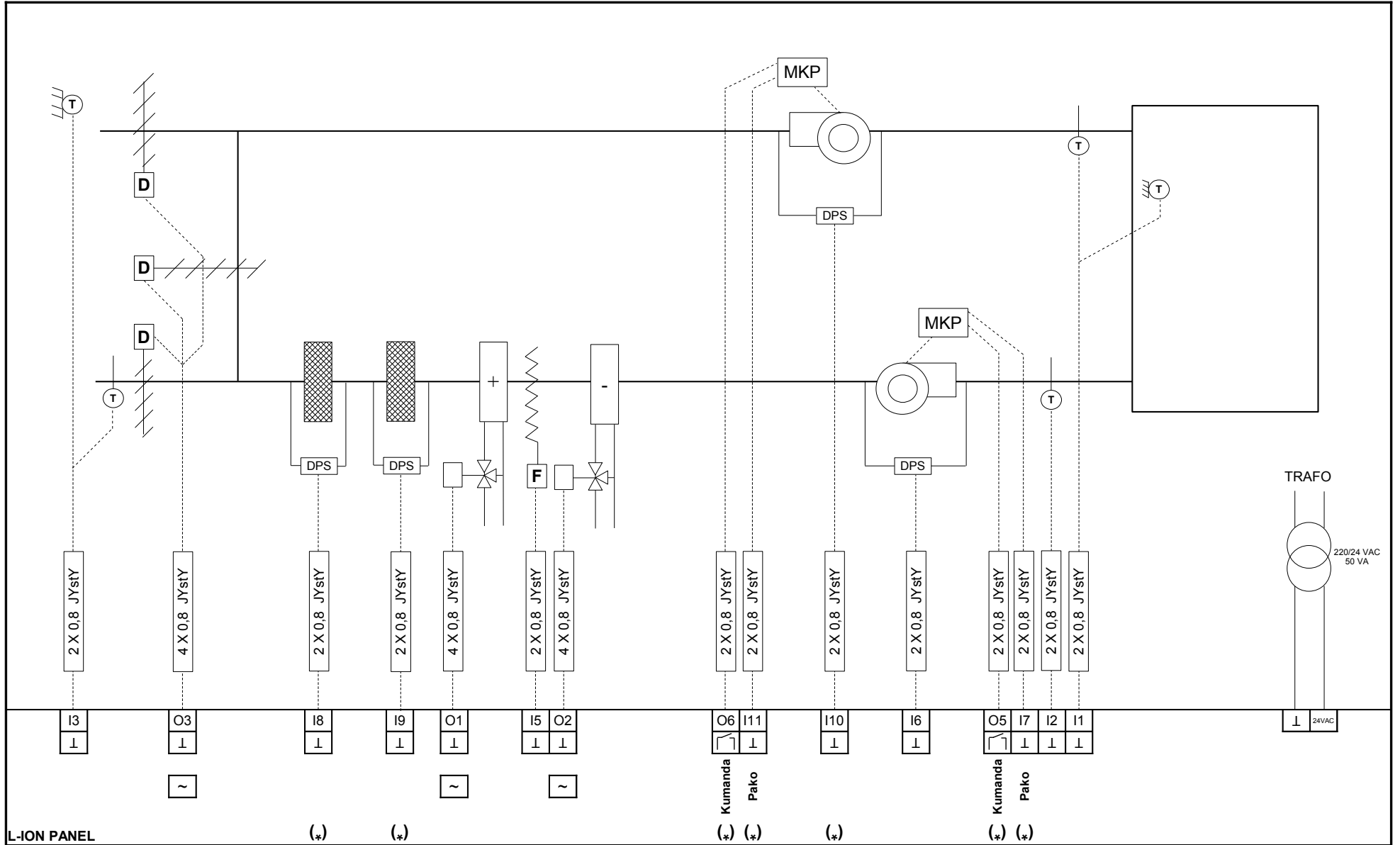

NOTLAR :

1-(*) İşaretili giriş/çıkışlar L-ION EP33 modelinde yoktur.

2-Röle çıkışlar 24VAC 5A'dır.



TEL: 0216 527 98 70
 FAX: 0216 527 98 71
 INTERNET: www.ontrol.com.tr

PROJE **ONTROL A.Ş**

SİSTEM **Senaryo Tip 13
 L-ION EP 44**

TARİH 03.09.2009
 REV.NO R01
 ÇİZEN AYSUN VAYIÇ

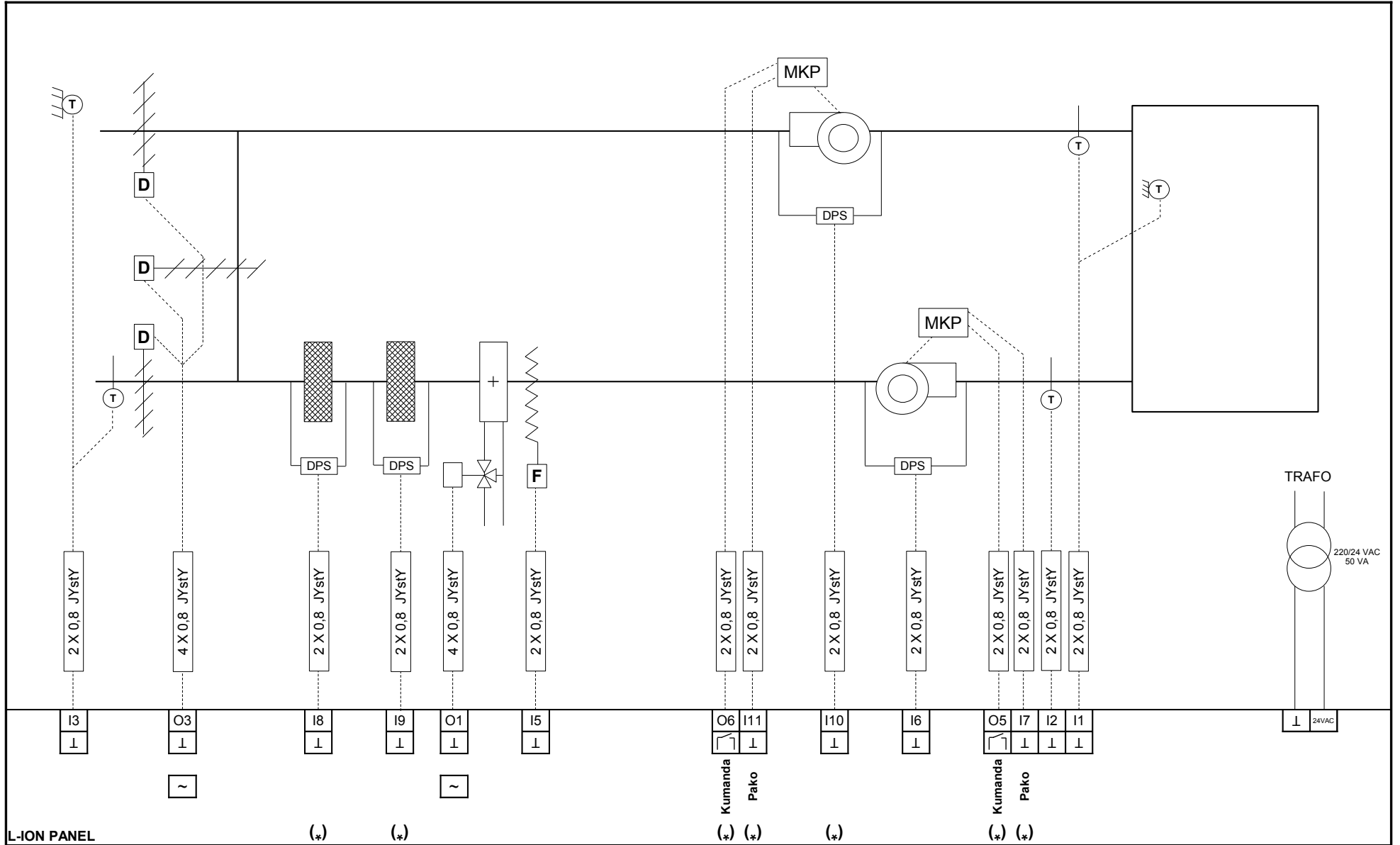

NOTLAR :

1-(*) İşaretili giriş/çıkışlar L-ION EP33 modelinde yoktur.

2-Röle çıkışlar 24VAC 5A'dır.



TEL: 0216 527 98 70
 FAX: 0216 527 98 71
 INTERNET: www.ontrol.com.tr

PROJE **ONTROL A.Ş**

SİSTEM **Senaryo Tip 14
 L-ION EP 44**

TARİH 03.09.2009
 REV.NO R01
 ÇİZEN AYSUN VAYIÇ

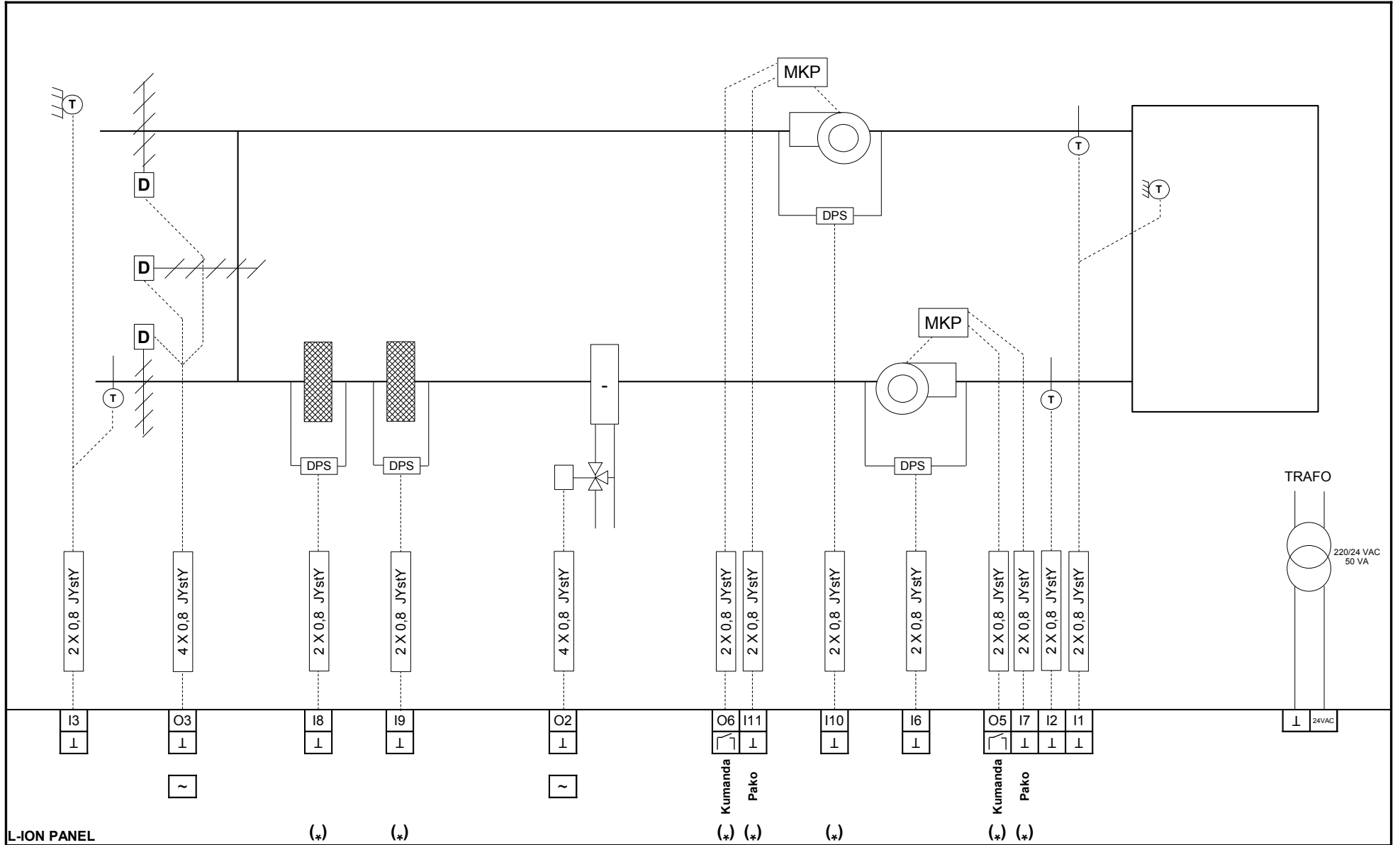

NOTLAR :

1-(*) İşaretili giriş/çıkışlar L-ION EP33 modelinde yoktur.

2-Röle çıkışlar 24VAC 5A'dır.



TEL: 0216 527 98 70
 FAX: 0216 527 98 71
 INTERNET: www.ontrol.com.tr

PROJE **ONTROL A.Ş**

SİSTEM **Senaryo Tip 15
 L-ION EP 44**

TARİH 03.09.2009
 REV.NO R01
 ÇİZEN AYSUN VAYIÇ

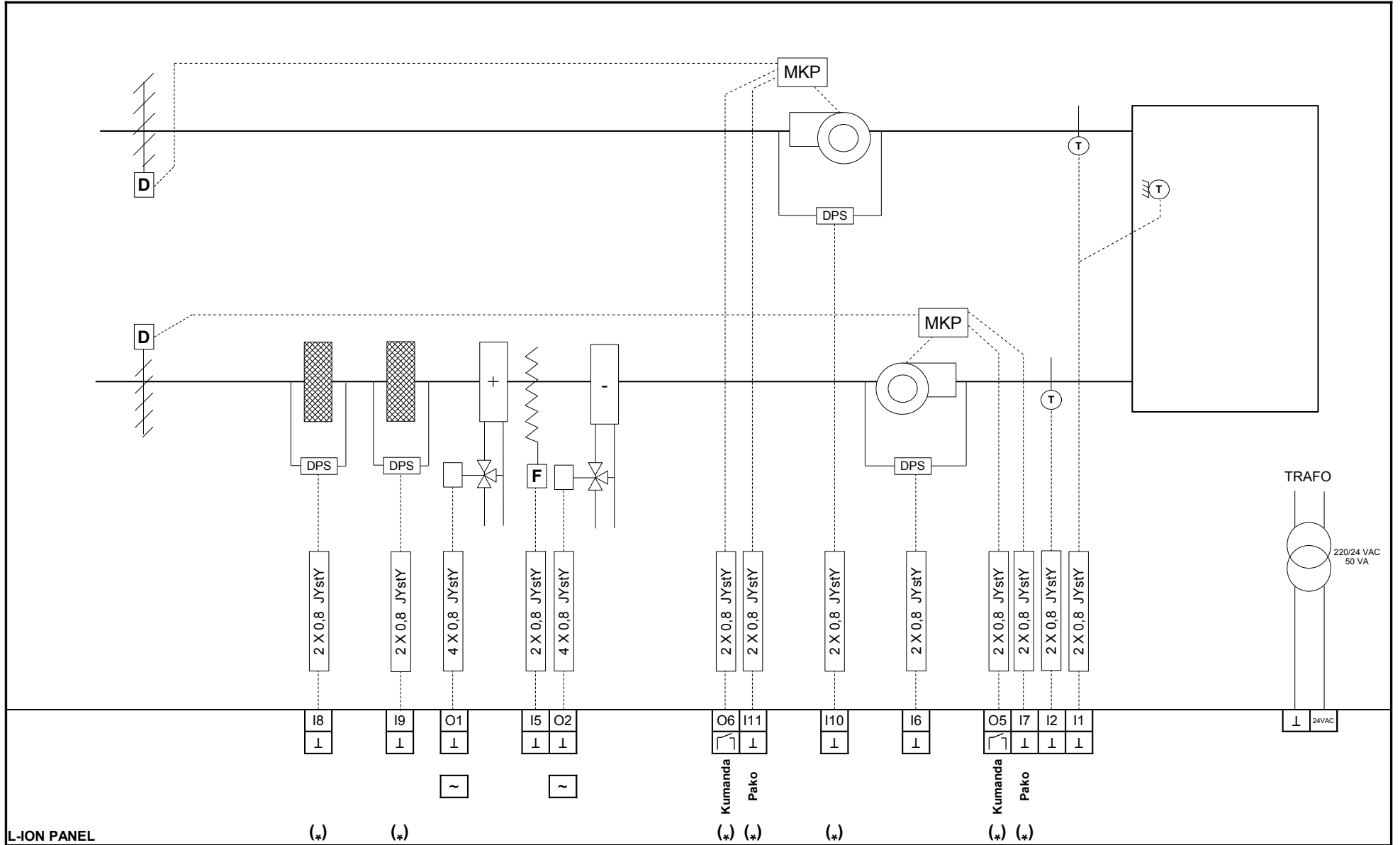

NOTLAR :

1-(*) İşaretili giriş/çıkışlar L-ION EP33 modelinde yoktur.

2-Röle çıkışlar 24VAC 5A'dır.



TEL: 0216 527 98 70
 FAX: 0216 527 98 71
 INTERNET: www.ontrol.com.tr

PROJE **ONTROL A.Ş**

SİSTEM **Senaryo Tip 16
 L-ION EP 44**

TARİH 03.09.2009
 REV.NO R01
 ÇİZEN AYSUN VAYIÇ

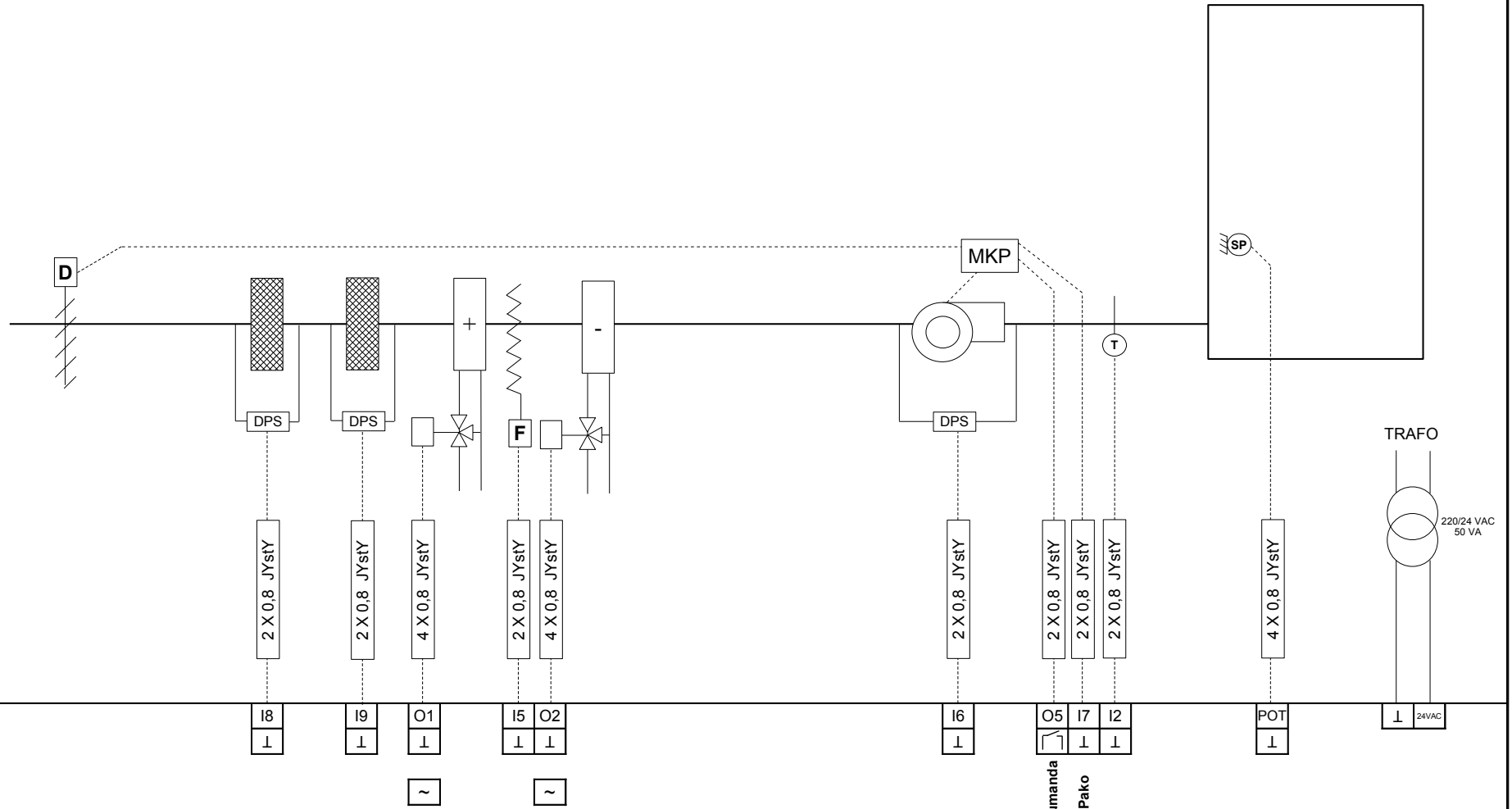

L-ION PANEL

(*)

(*)

(*)

(*)

NOTLAR :

1-(*) İşaretili giriş/çıkışlar L-ION EP33 modelinde yoktur.

2-Röle çıkışlar 24VAC 5A'dır.



TEL: 0216 527 98 70
FAX: 0216 527 98 71
INTERNET: www.ontrol.com.tr

PROJE
ONTROL A.Ş

SİSTEM
**Senaryo Tip 17
L-ION EP 44**

TARİH: 03.09.2009
REV.NO: R01
ÇİZEN: AYSUN VAYIÇ

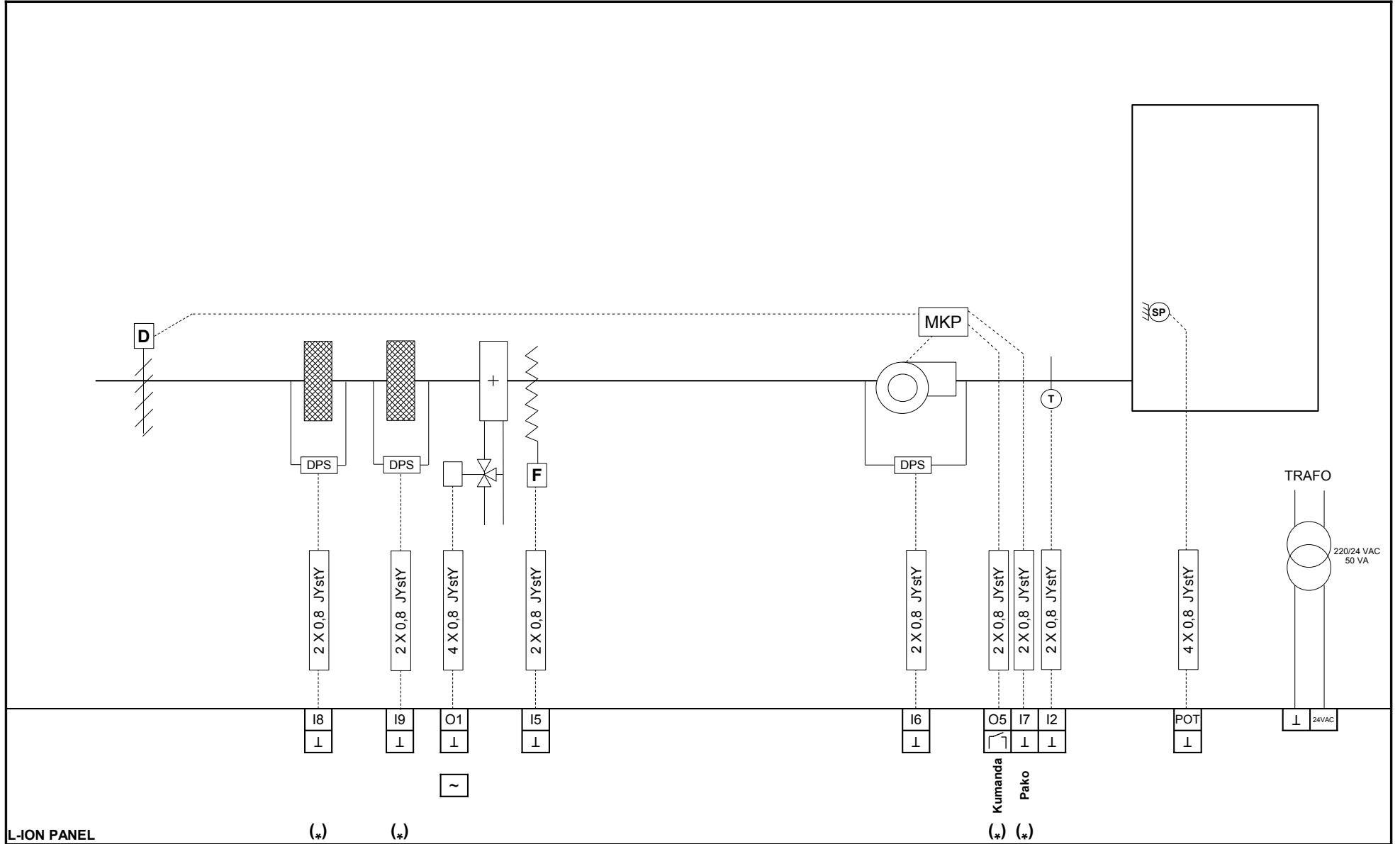

L-ION PANEL

NOTLAR :

1-(*) İşaretili giriş/çıkışlar L-ION EP33 modelinde yoktur.

2-Röle çıkışlar 24VAC 5A'dır.



TEL: 0216 527 98 70
 FAX: 0216 527 98 71
 INTERNET: www.ontrol.com.tr

PROJE
ONTROL A.Ş

SİSTEM
**Senaryo Tip 18
 L-ION EP 44**

TARİH 03.09.2009
 REV.NO R01
 ÇİZEN AYSUN VAYIÇ

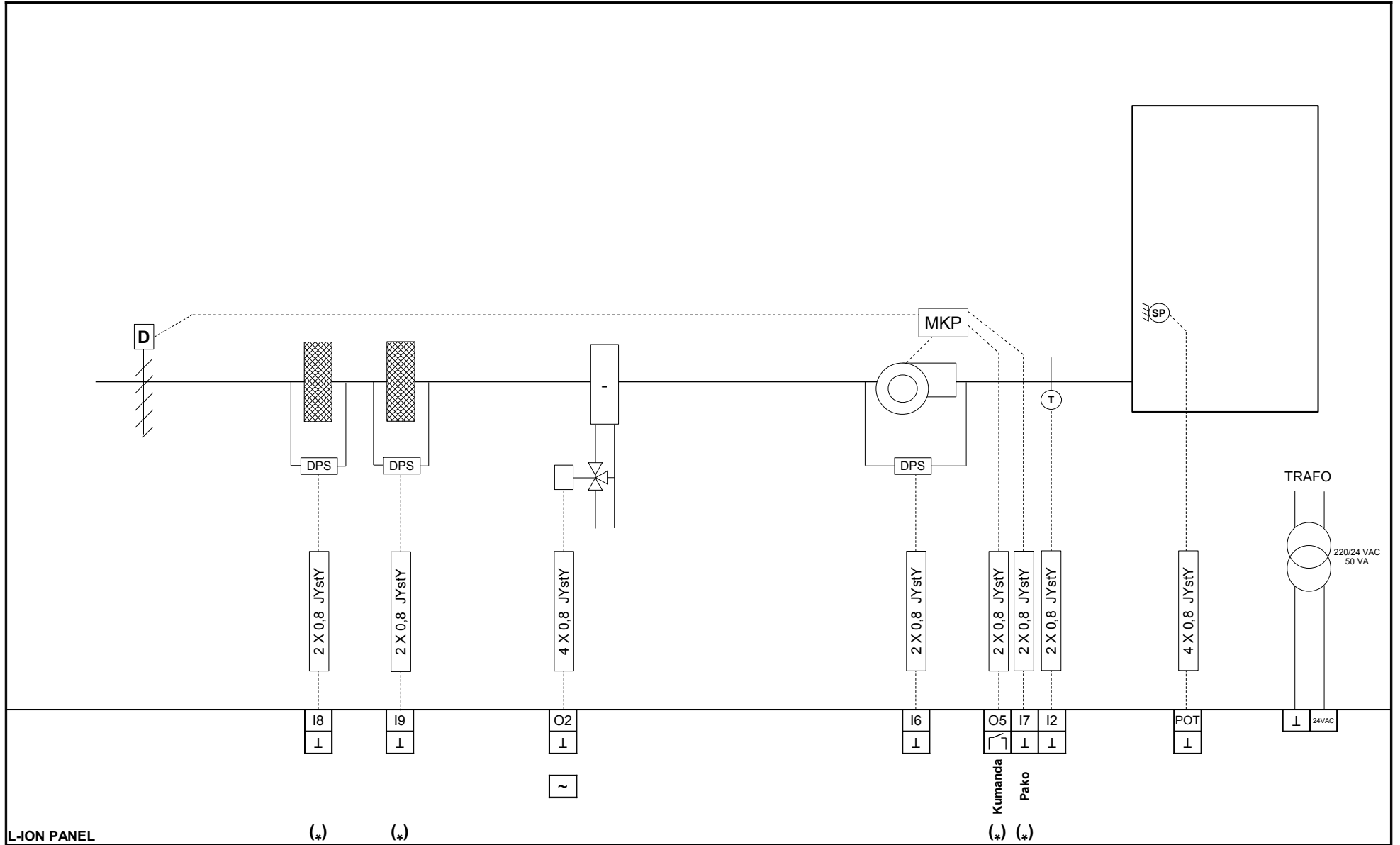

NOTLAR :

1-(*) İşaretili giriş/çıkışlar L-ION EP33 modelinde yoktur.

2-Röle çıkışlar 24VAC 5A'dır.



TEL: 0216 527 98 70
 FAX: 0216 527 98 71
 INTERNET: www.ontrol.com.tr

PROJE **ONTROL A.Ş**

SİSTEM **Senaryo Tip 19
 L-ION EP 44**

TARİH 03.09.2009
 REV.NO R01
 ÇİZEN AYSUN VAYIÇ

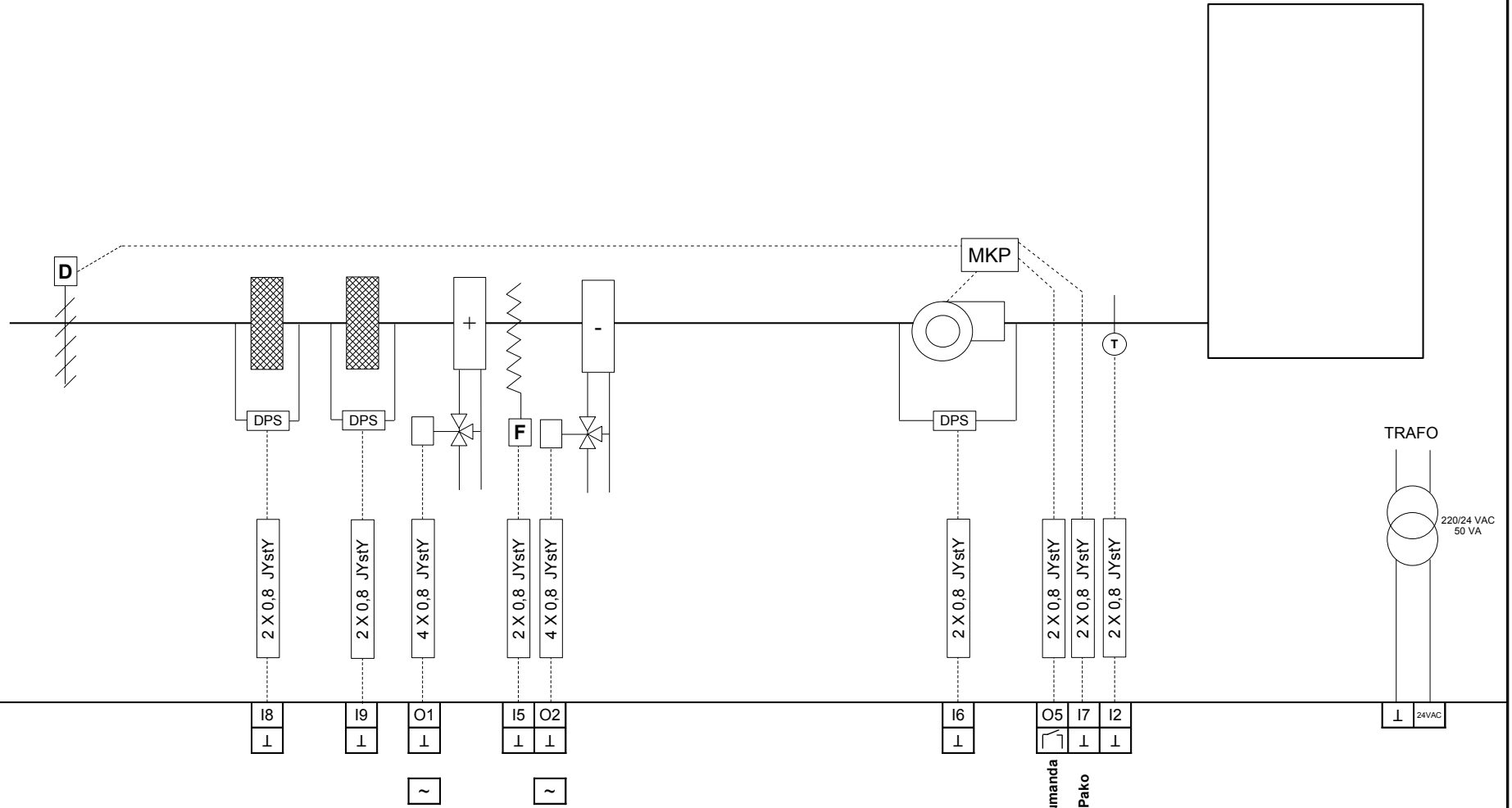

L-ION PANEL

NOTLAR :

1-(*) İşaretili giriş/çıkışlar L-ION EP33 modelinde yoktur.

2-Röle çıkışlar 24VAC 5A'dır.



TEL: 0216 527 98 70
 FAX: 0216 527 98 71
 INTERNET: www.ontrol.com.tr

PROJE
ONTROL A.Ş

SİSTEM
Senaryo Tip 20
L-ION EP 44

TARİH 03.09.2009
 REV.NO R01
 ÇİZEN AYSUN VAYIÇ

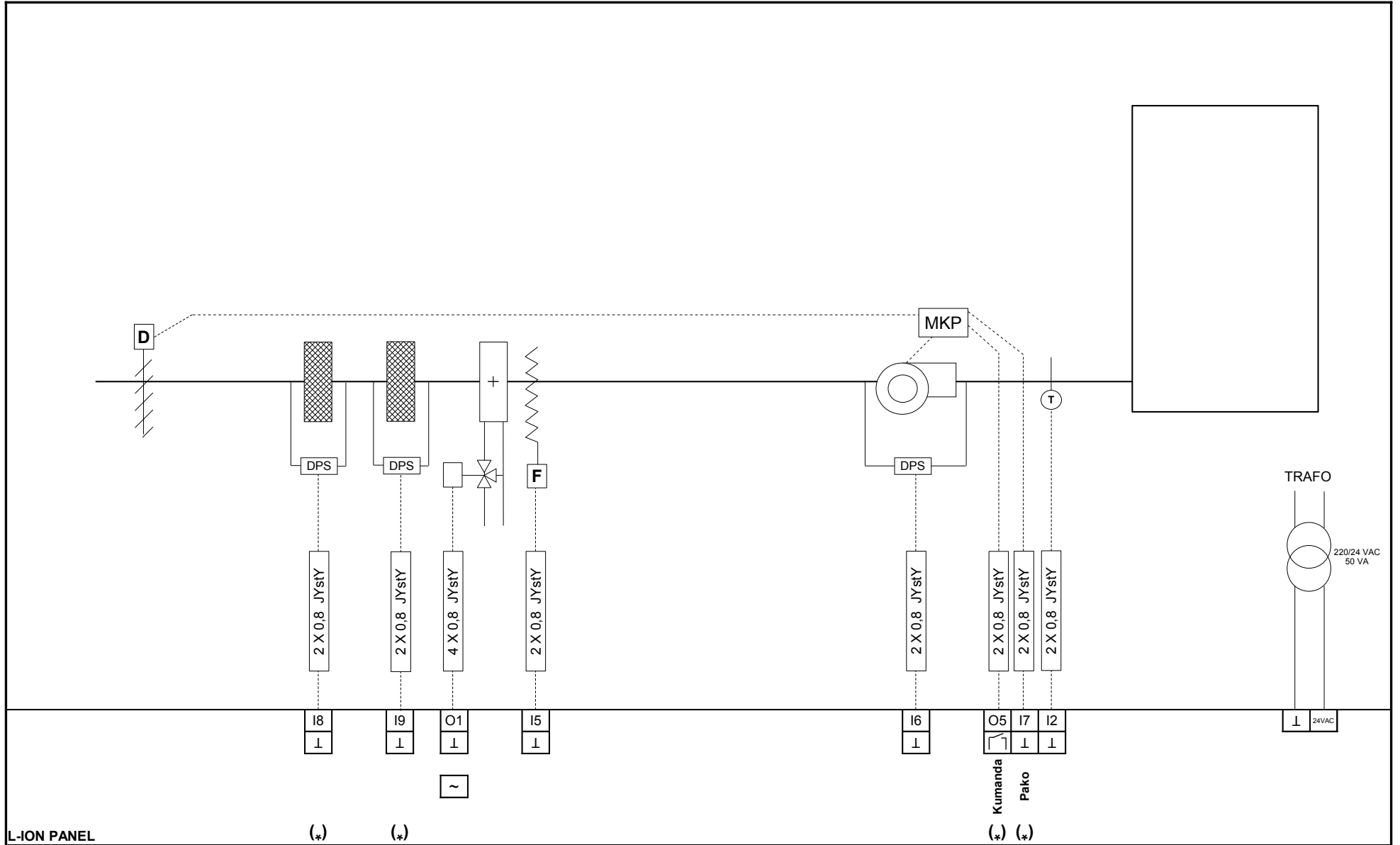

L-ION PANEL

(*)

(*)

(*)

(*)

NOTLAR :

1-(*) İşaretili giriş/çıkışlar L-ION EP33 modelinde yoktur.

2-Röle çıkışlar 24VAC 5A'dır.



TEL: 0216 527 98 70
FAX: 0216 527 98 71
INTERNET: www.ontrol.com.tr

PROJE **ONTROL A.Ş**

SİSTEM **Senaryo Tip 21
L-ION EP 44**

TARİH 03.09.2009
REV.NO R01
ÇİZEN AYSUN VAYIÇ

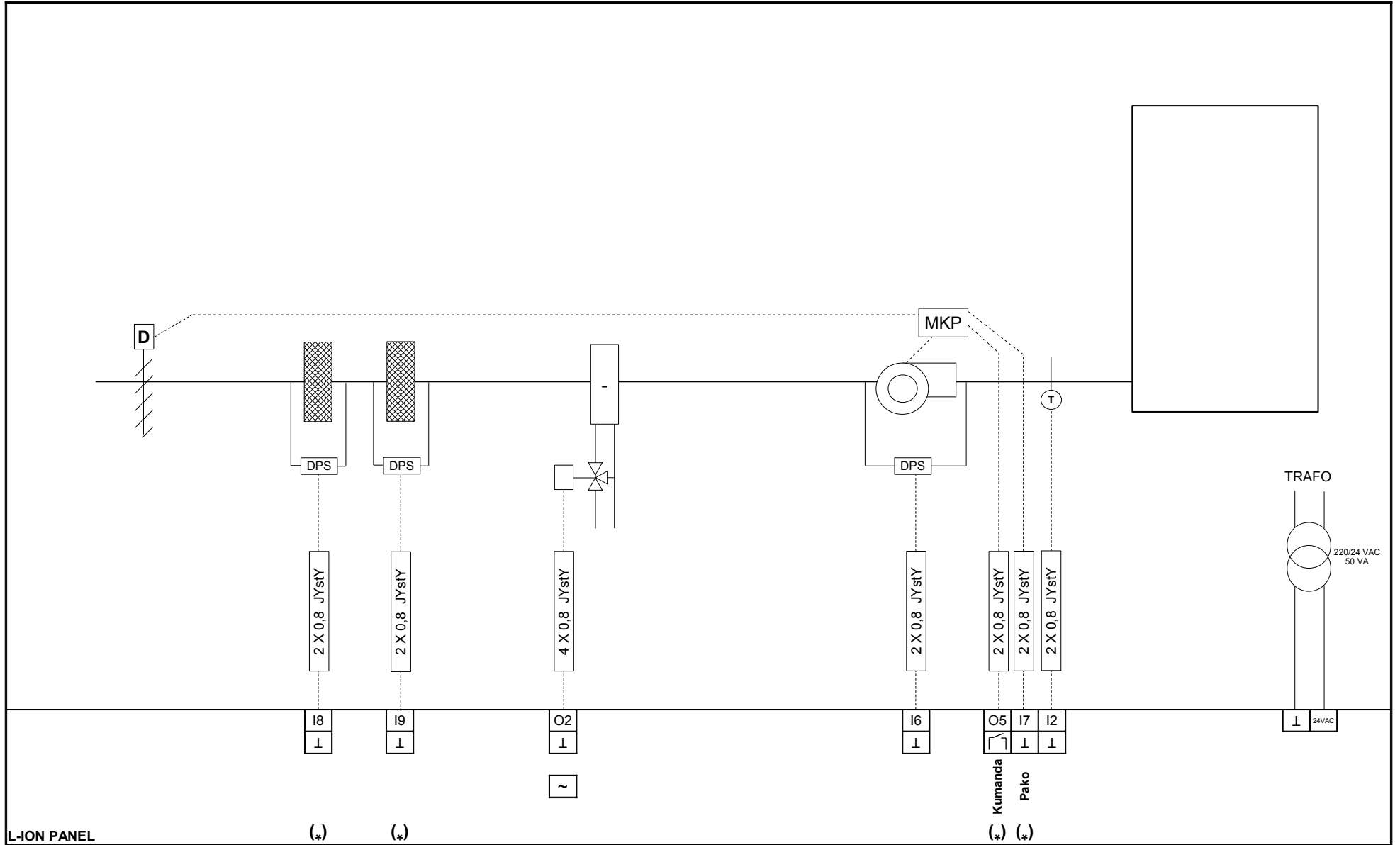

NOTLAR :

1-(*) İşaretili giriş/çıkışlar L-ION EP33 modelinde yoktur.

2-Röle çıkışlar 24VAC 5A'dır.



TEL: 0216 527 98 70
 FAX: 0216 527 98 71
 INTERNET: www.ontrol.com.tr

PROJE **ONTROL A.Ş**

SİSTEM **Senaryo Tip 22
 L-ION EP 44**

TARİH	03.09.2009
REV.NO	R01
ÇİZEN	AYSUN VAYIÇ

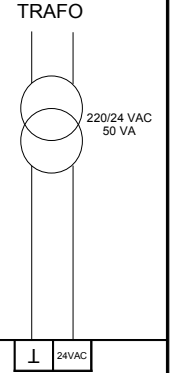
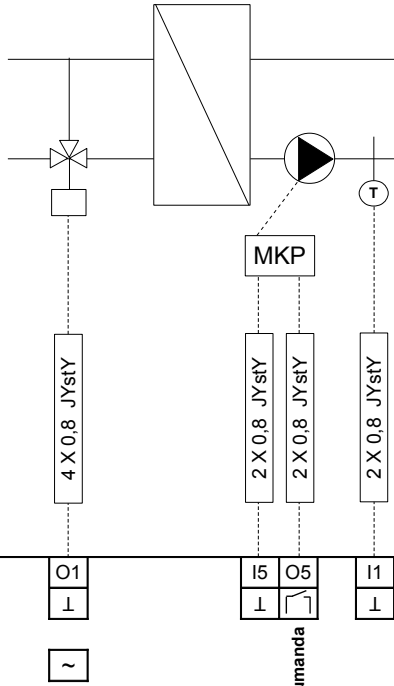

L-ION PANEL

NOTLAR :

1-(*) İşaretili giriş/çıkışlar L-ION EP33 modelinde yoktur.

2-Röle çıkışlar 24VAC 5A'dır.





TEL: 0216 527 98 70
 FAX: 0216 527 98 71
 INTERNET: www.ontrol.com.tr

PROJE **ONTROL A.Ş**

SİSTEM **Eşanjör Tip 23
 L-ION EP 44**

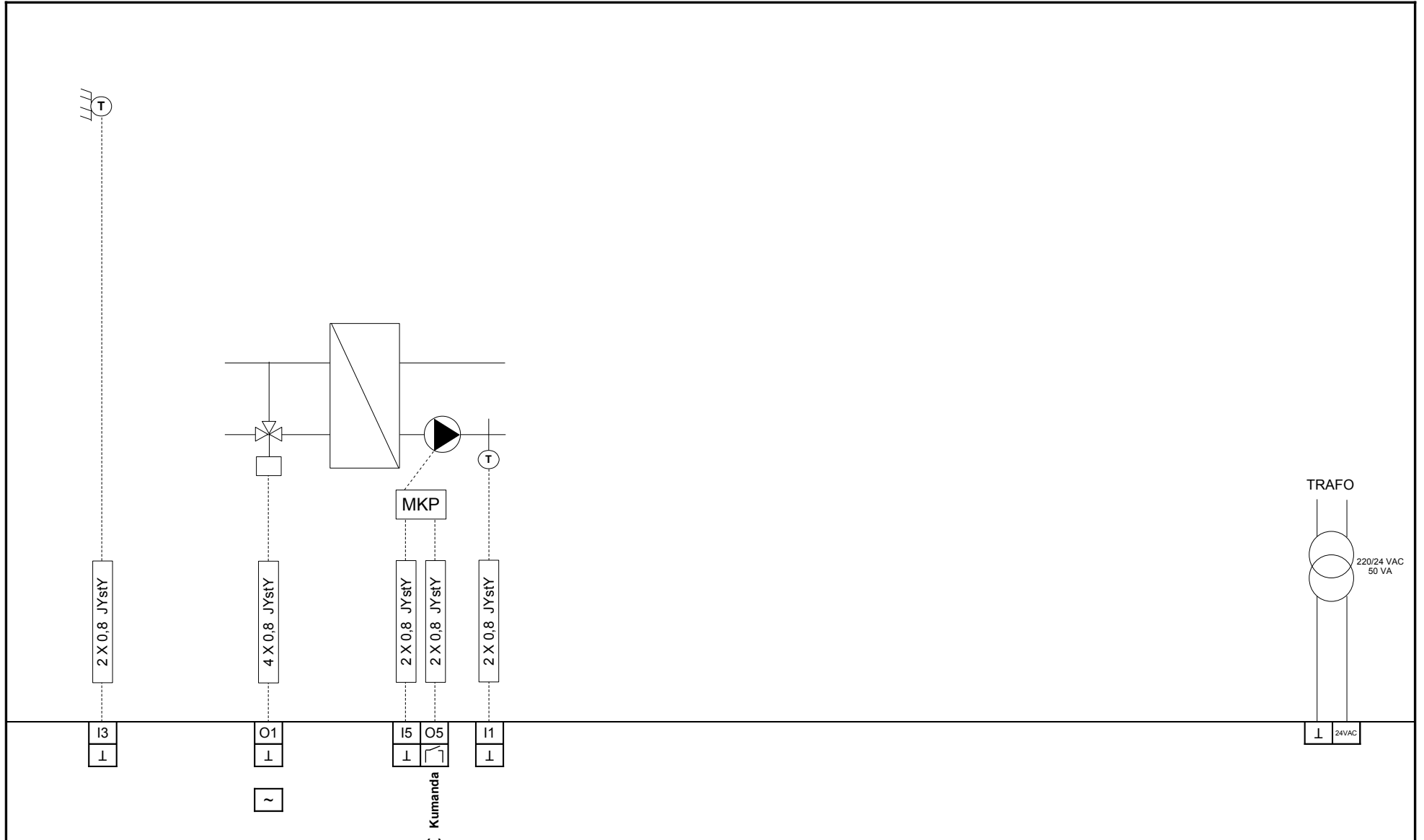
TARİH	03.09.2009
REV.NO	R01
ÇİZEN	AYSUN VAYIÇ



	TEL: 0216 527 98 70	PROJE ONTROL A.Ş	SİSTEM Eşanjör Tip 24 L-ION EP 44	TARİH 03.09.2009
	FAX: 0216 527 98 71			REV.NO R01
	INTERNET: www.ontrol.com.tr			ÇİZEN AYSUN VAYIÇ

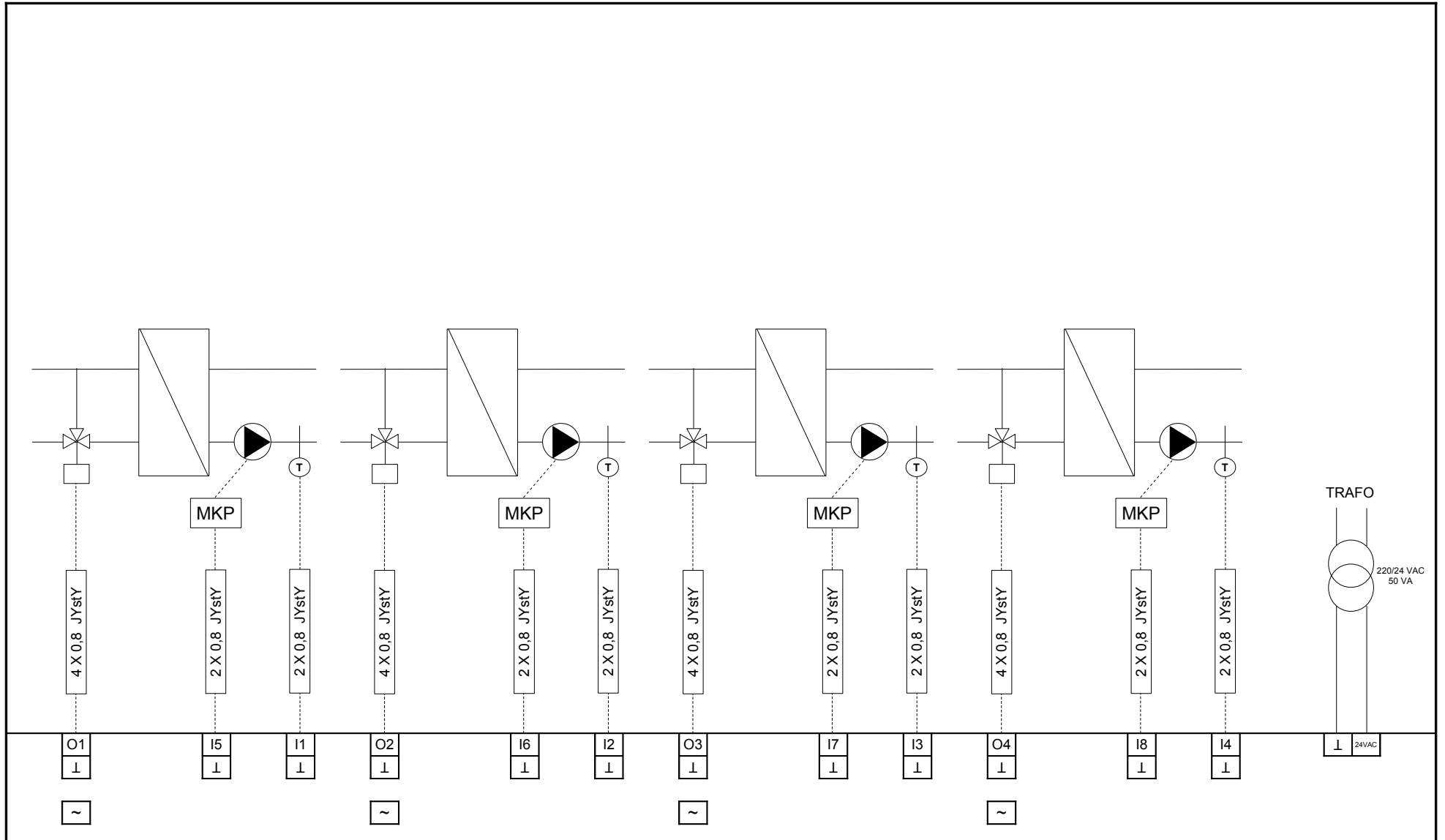

L-ION PANEL

NOTLAR :

1-(*) İşaretili giriş/çıkışlar L-ION EP33 modelinde yoktur.

2-Röle çıkışlar 24VAC 5A'dir.

	TEL: 0216 527 98 70	PROJE ONTROL A.Ş	SİSTEM Eşanjör Tip 25 L-ION EP 44	TARİH: 03.09.2009
	FAX: 0216 527 98 71			REV.NO: R01
	INTERNET: www.ontrol.com.tr			ÇİZEN: AYSUN VAYIÇ

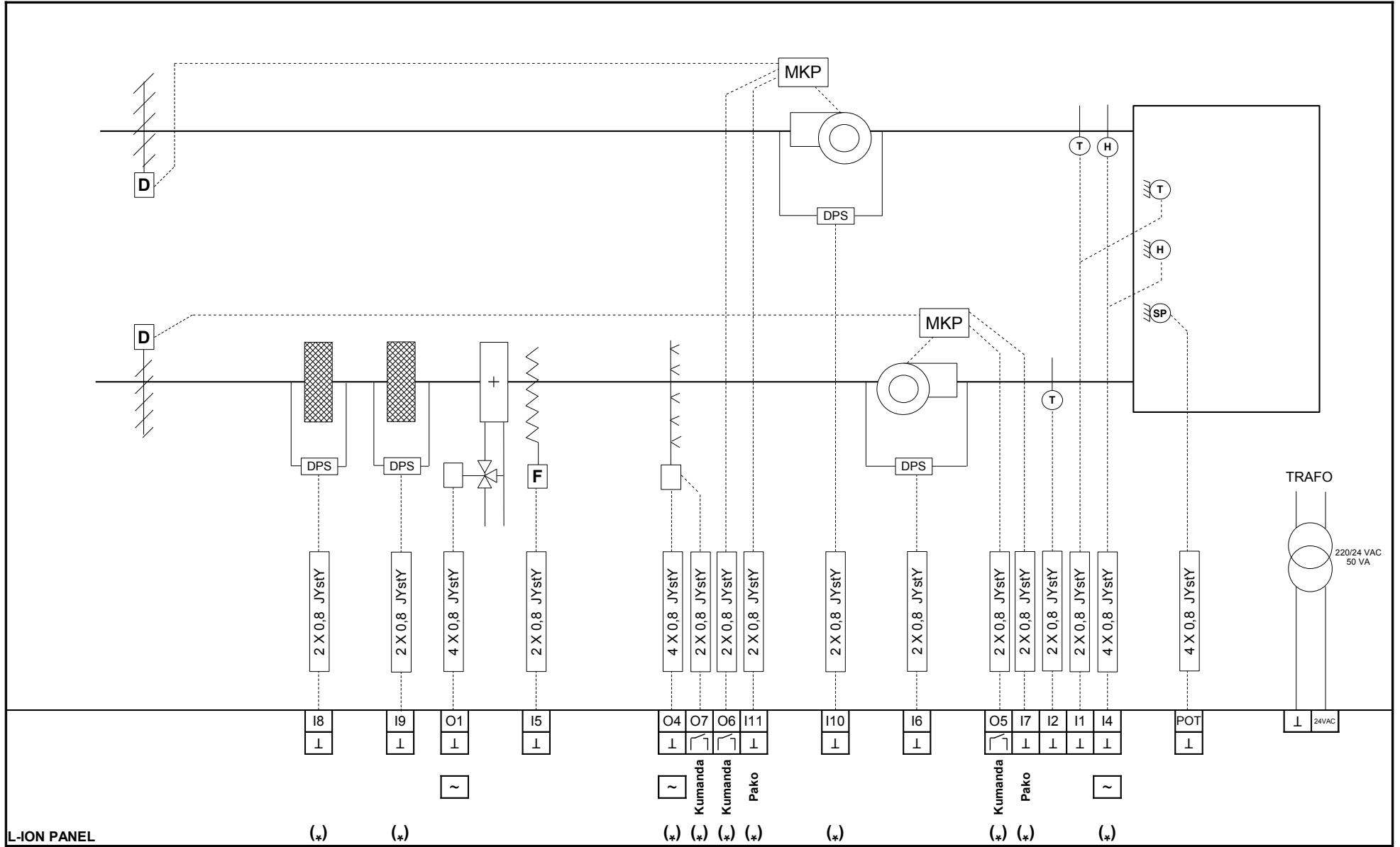

NOTLAR :

1-(*) İşaretili giriş/çıkışlar L-ION EP33 modelinde yoktur.

2-Röle çıkışlar 24VAC 5A'dır.



TEL: 0216 527 98 70
 FAX: 0216 527 98 71
 INTERNET: www.ontrol.com.tr

PROJE **ONTROL A.Ş**

SİSTEM **Senaryo Tip 26
 L-ION EP 44**

TARİH 03.09.2009
 REV.NO R01
 ÇİZEN AYSUN VAYIÇ

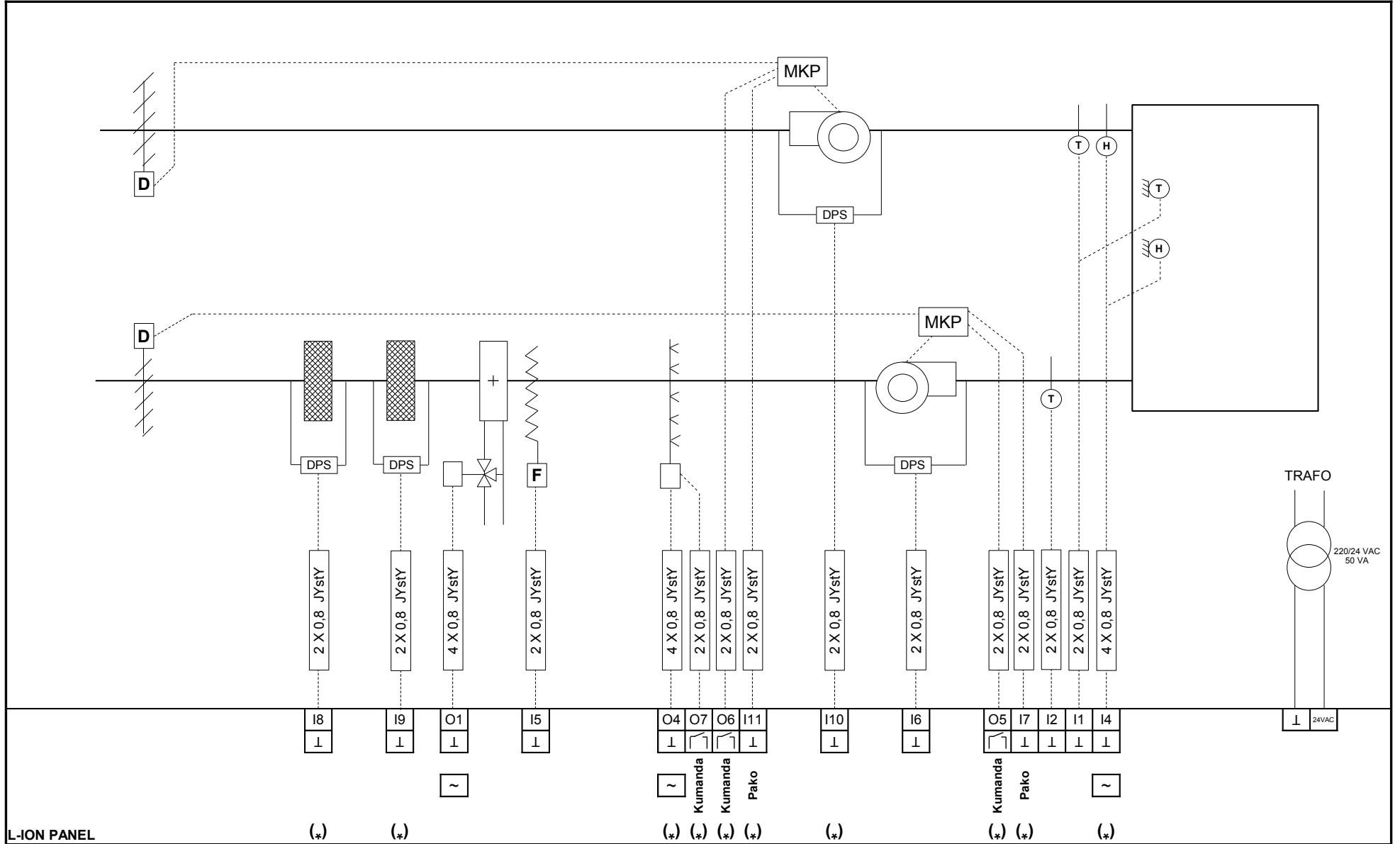

NOTLAR :

1-(*) İşaretili giriş/çıkışlar L-ION EP33 modelinde yoktur.

2-Röle çıkışlar 24VAC 5A'dır.



TEL: 0216 527 98 70
 FAX: 0216 527 98 71
 INTERNET: www.ontrol.com.tr

PROJE **ONTROL A.Ş**

SİSTEM **Senaryo Tip 28
 L-ION EP 44**

TARİH 03.09.2009
 REV.NO R01
 ÇİZEN AYSUN VAYIÇ

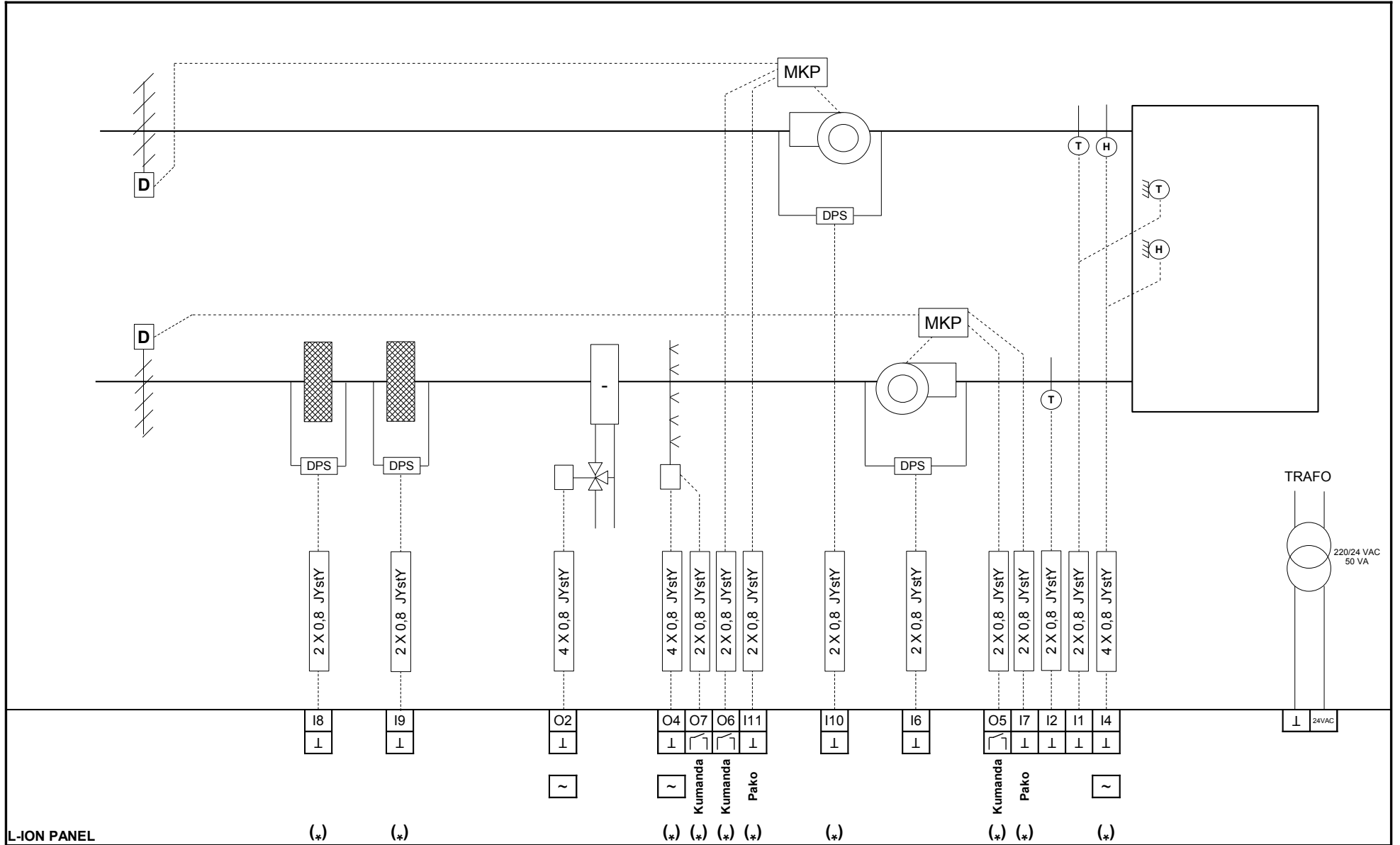

NOTLAR :

1-(*) İşaretili giriş/çıkışlar L-ION EP33 modelinde yoktur.

2-Röle çıkışlar 24VAC 5A'dır.



TEL: 0216 527 98 70
 FAX: 0216 527 98 71
 INTERNET: www.ontrol.com.tr

PROJE **ONTROL A.Ş**

SİSTEM **Senaryo Tip 29
 L-ION EP 44**

TARİH 03.09.2009
 REV.NO R01
 ÇİZEN AYSUN VAYIÇ

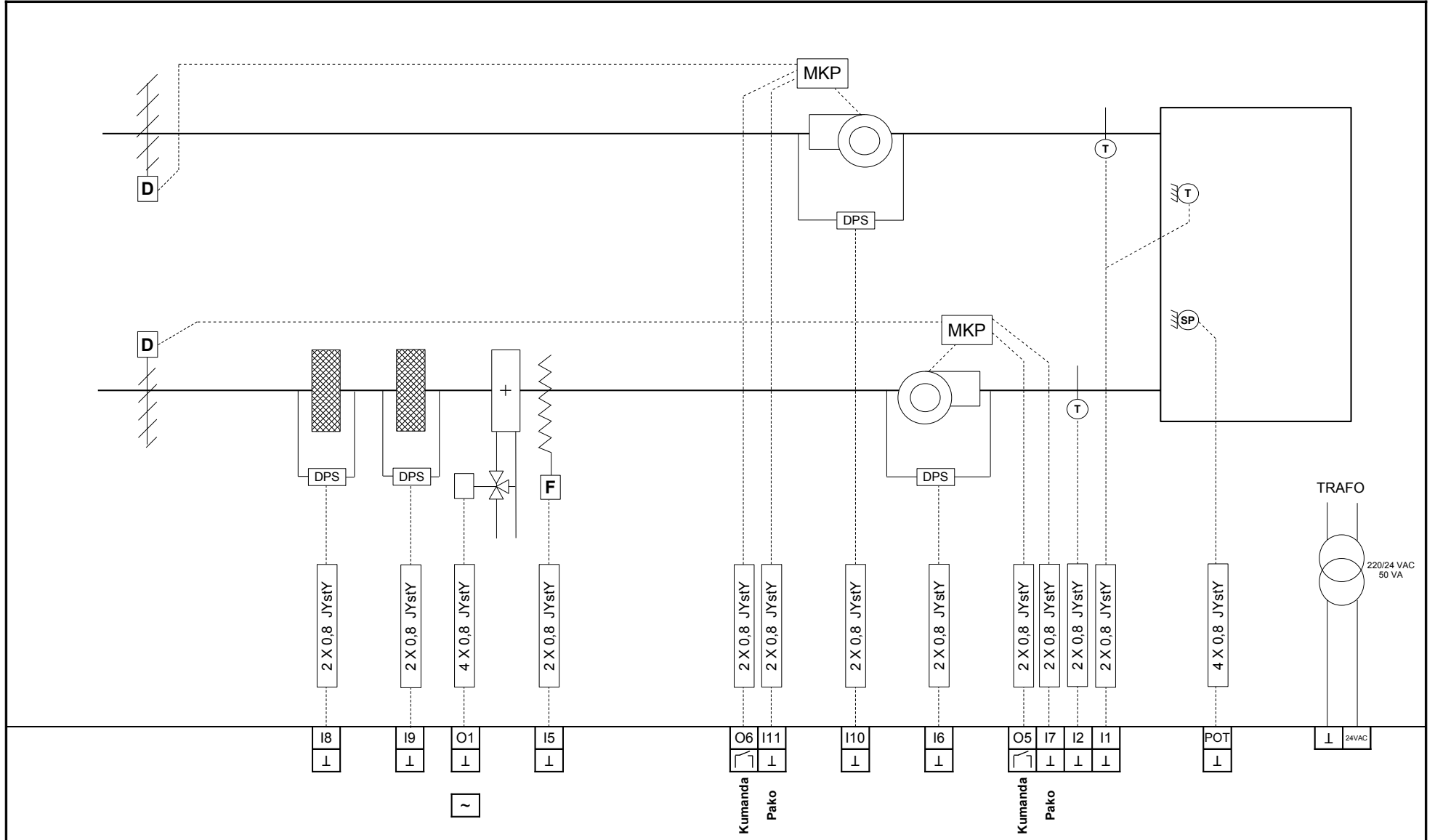

L-ION PANEL

(*)

(*)

(*)

(*)

(*)

(*)

(*)

NOTLAR :

1-(*) İşaretili giriş/çıkışlar L-ION EP33 modelinde yoktur.

2-Röle çıkışlar 24VAC 5A'dır.



TEL: 0216 527 98 70
 FAX: 0216 527 98 71
 INTERNET: www.ontrol.com.tr

PROJE
ONTROL A.Ş

SİSTEM
**Senaryo Tip 30
 L-ION EP 44**

TARİH 03.09.2009
 REV.NO R01
 ÇİZEN AYSUN VAYIÇ

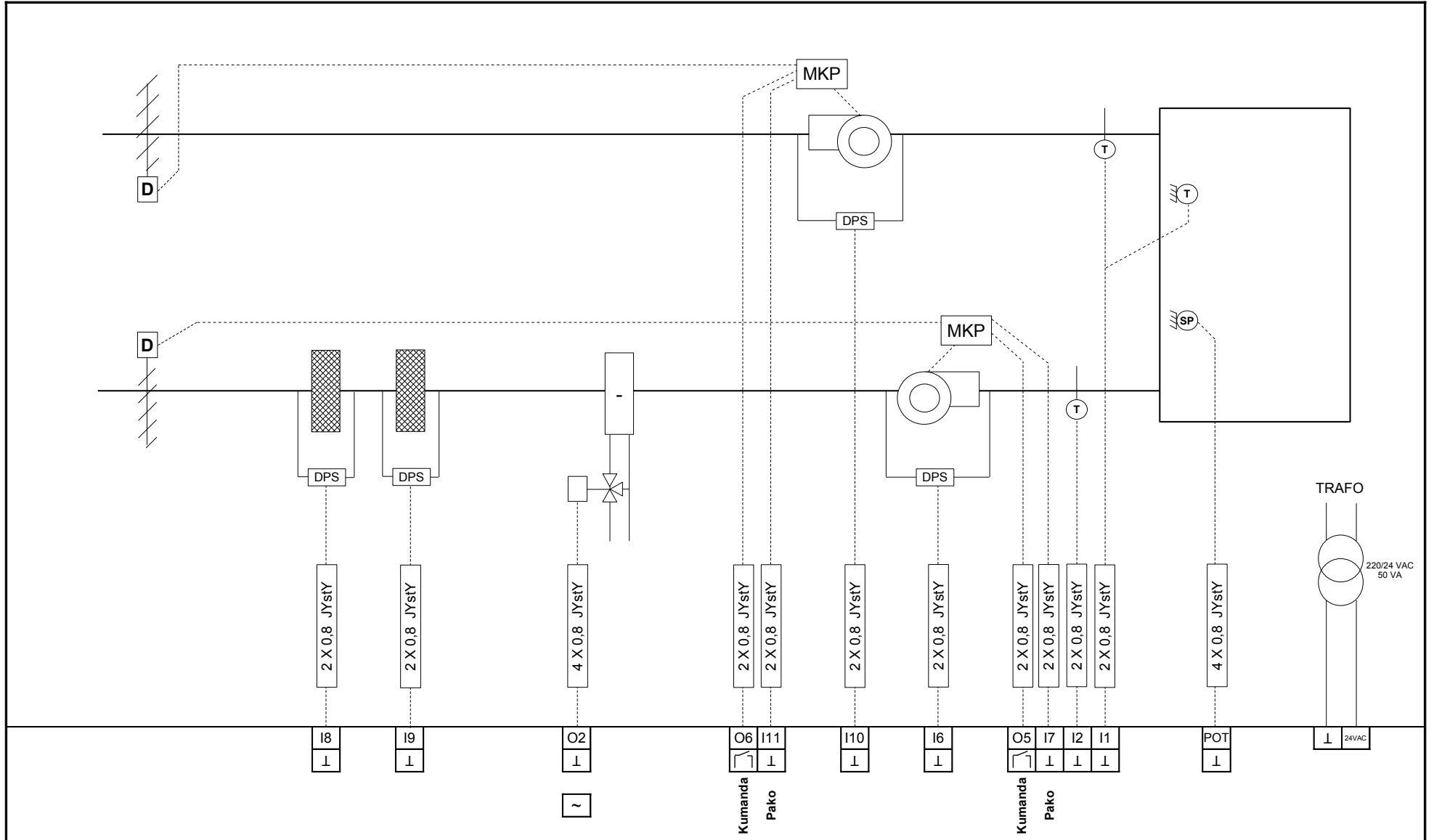

L-ION PANEL

(*)

(*)

(*)

(*)

(*)

(*)

(*)

NOTLAR :

1-(*) İşaretili giriş/çıkışlar L-ION EP33 modelinde yoktur.

2-Röle çıkışlar 24VAC 5A'dır.



TEL: 0216 527 98 70
FAX: 0216 527 98 71
INTERNET: www.ontrol.com.tr

PROJE
ONTROL A.Ş

SİSTEM
**Senaryo Tip 31
L-ION EP 44**

TARİH 03.09.2009
REV.NO R01
ÇİZEN AYSUN VAYIÇ

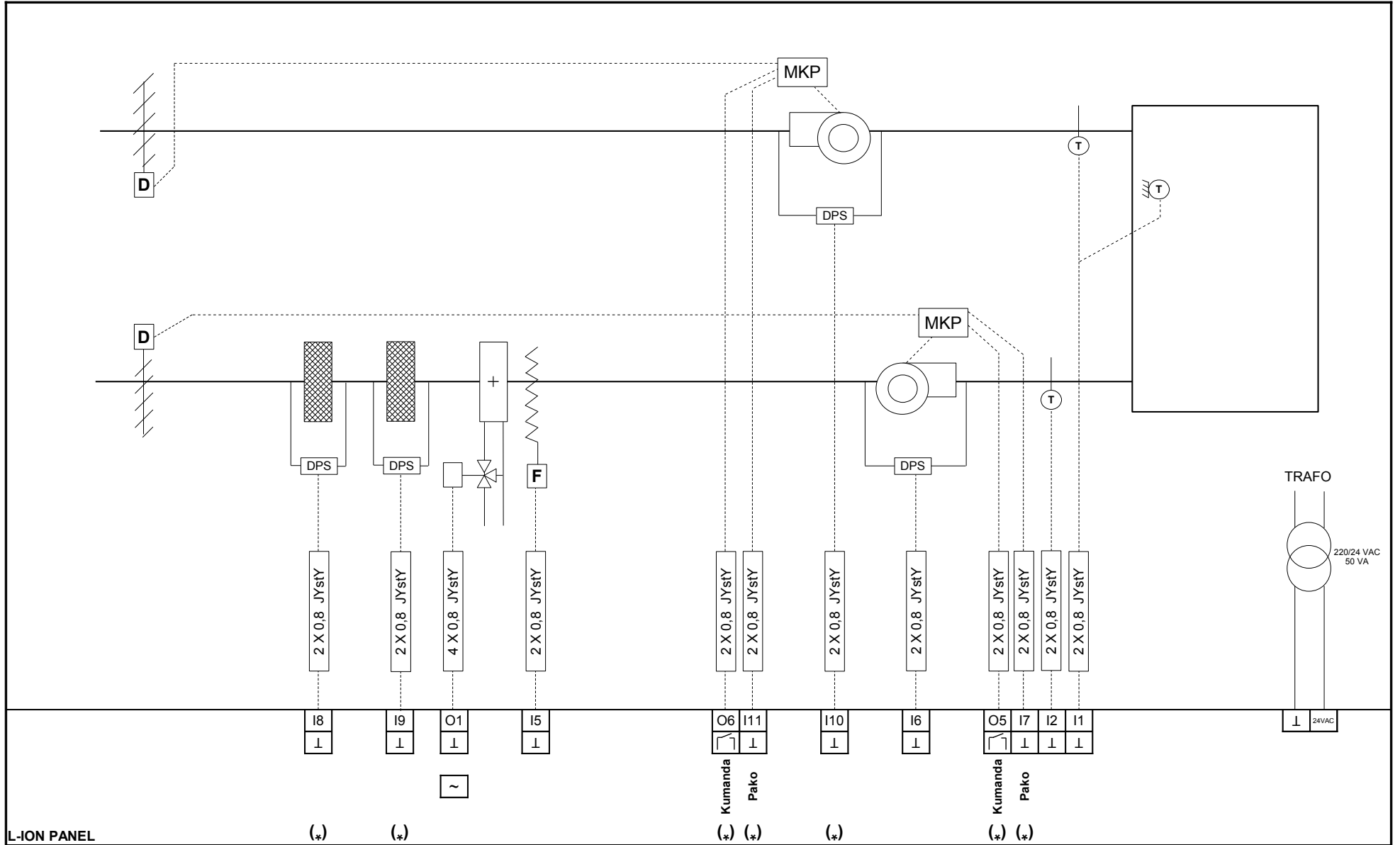

NOTLAR :

1-(*) İşaretili giriş/çıkışlar L-ION EP33 modelinde yoktur.

2-Röle çıkışlar 24VAC 5A'dır.



TEL: 0216 527 98 70
 FAX: 0216 527 98 71
 INTERNET: www.ontrol.com.tr

PROJE **ONTROL A.Ş**

SİSTEM **Senaryo Tip 32
 L-ION EP 44**

TARİH 03.09.2009
 REV.NO R01
 ÇİZEN AYSUN VAYIÇ

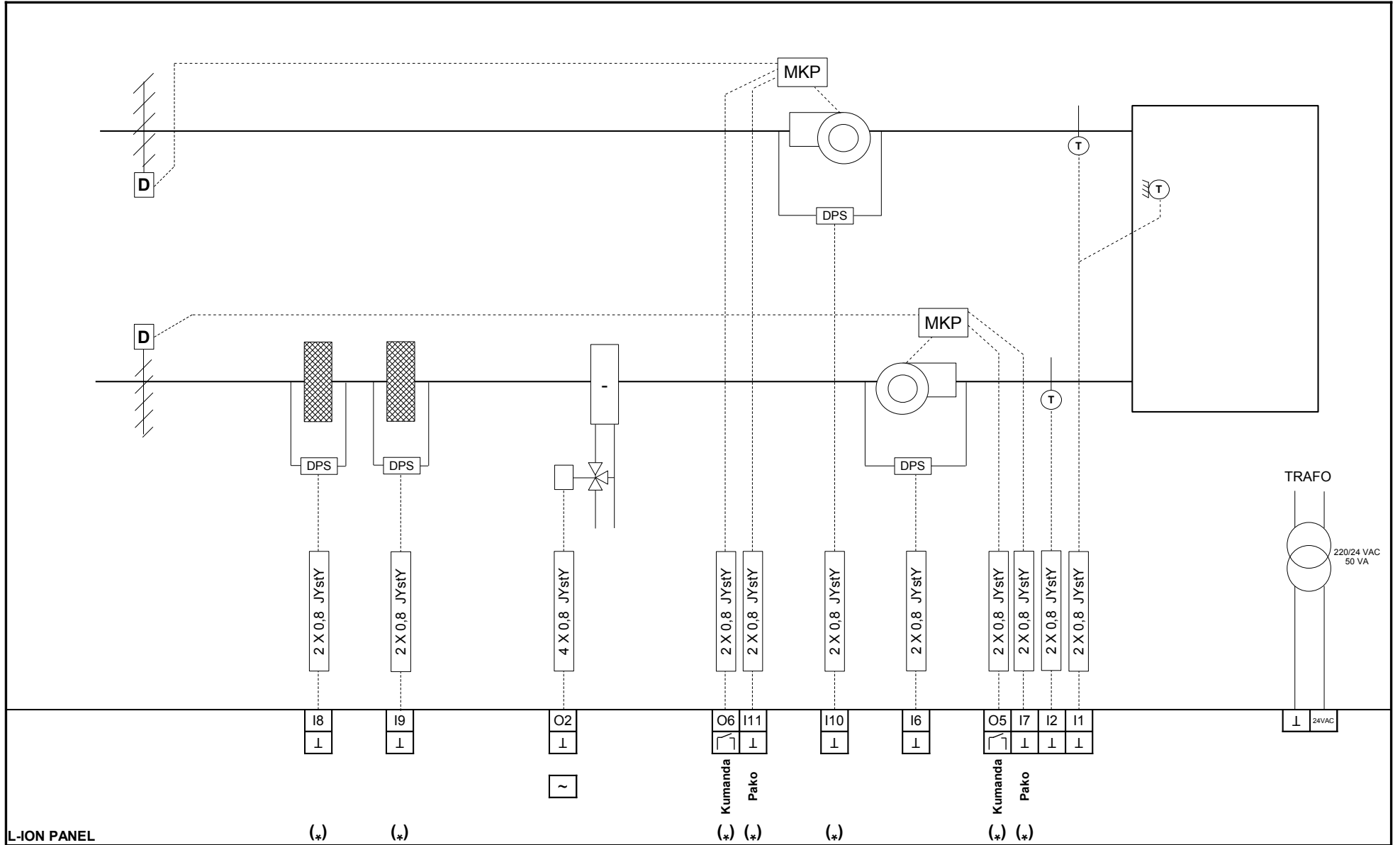

NOTLAR :

1-(*) İşaretili giriş/çıkışlar L-ION EP33 modelinde yoktur.

2-Röle çıkışlar 24VAC 5A'dır.



TEL: 0216 527 98 70
 FAX: 0216 527 98 71
 INTERNET: www.ontrol.com.tr

PROJE **ONTROL A.Ş**

SİSTEM **Senaryo Tip 33
 L-ION EP 44**

TARİH 03.09.2009
 REV.NO R01
 ÇİZEN AYSUN VAYIÇ

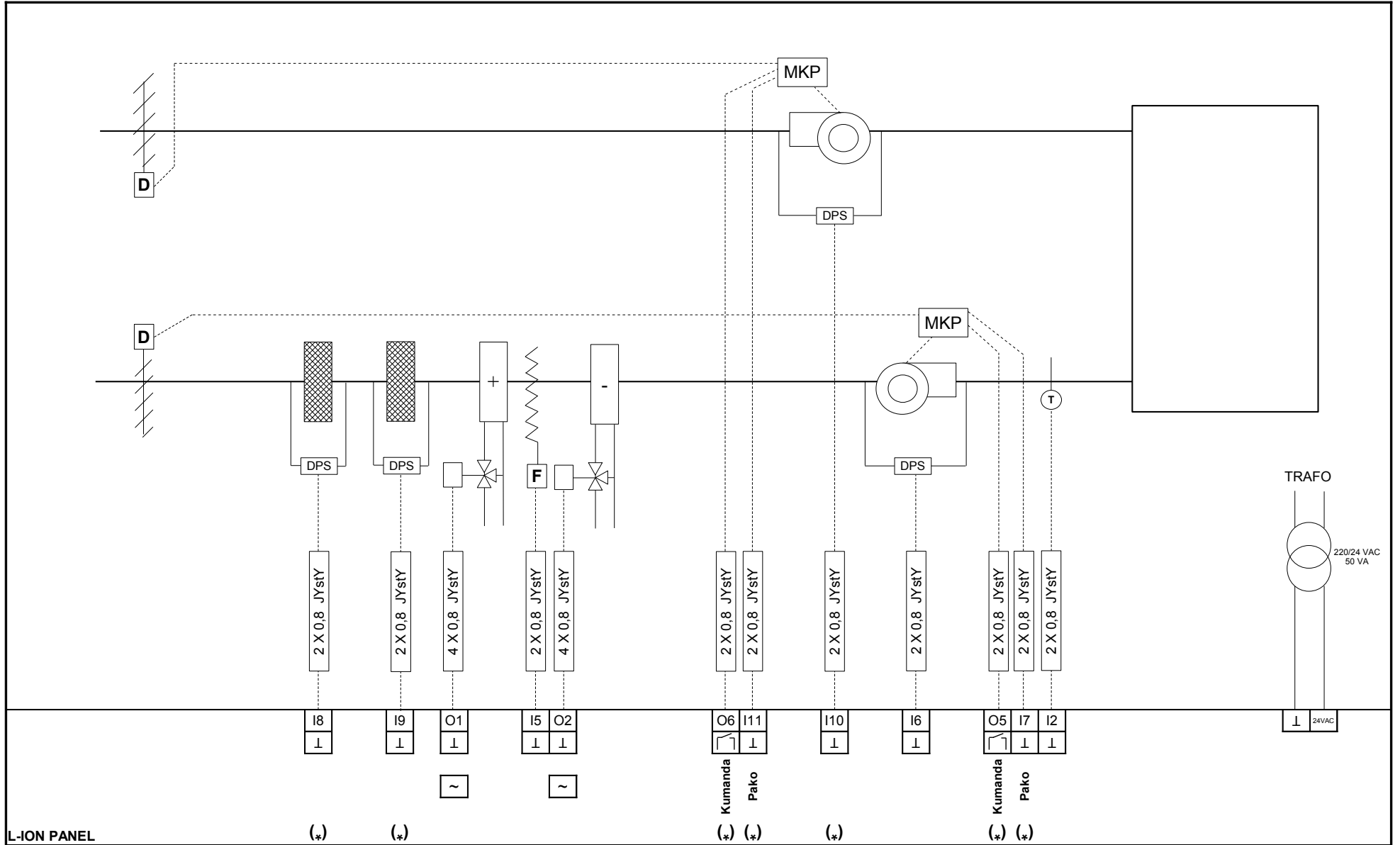

NOTLAR :

1-(*) İşaretili giriş/çıkışlar L-ION EP33 modelinde yoktur.

2-Röle çıkışlar 24VAC 5A'dır.



TEL: 0216 527 98 70
 FAX: 0216 527 98 71
 INTERNET: www.ontrol.com.tr

PROJE **ONTROL A.Ş**

SİSTEM **Senaryo Tip 34
 L-ION EP 44**

TARİH 03.09.2009
 REV.NO R01
 ÇİZEN AYSUN VAYIÇ

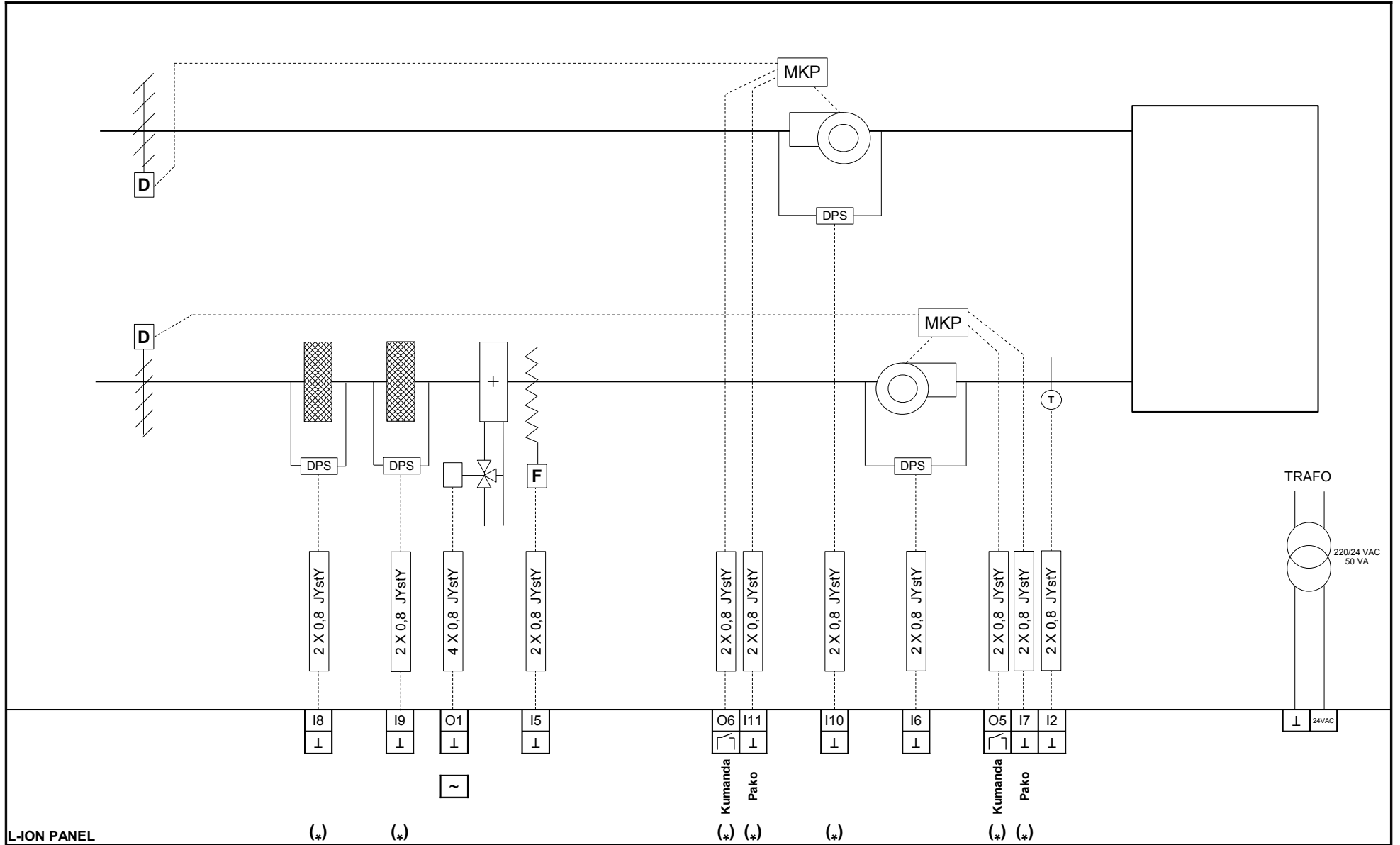

NOTLAR :

1-(*) İşaretili giriş/çıkışlar L-ION EP33 modelinde yoktur.

2-Röle çıkışlar 24VAC 5A'dır.



TEL: 0216 527 98 70
 FAX: 0216 527 98 71
 INTERNET: www.ontrol.com.tr

PROJE **ONTROL A.Ş**

SİSTEM **Senaryo Tip 35
 L-ION EP 44**

TARİH 03.09.2009
 REV.NO R01
 ÇİZEN AYSUN VAYIÇ

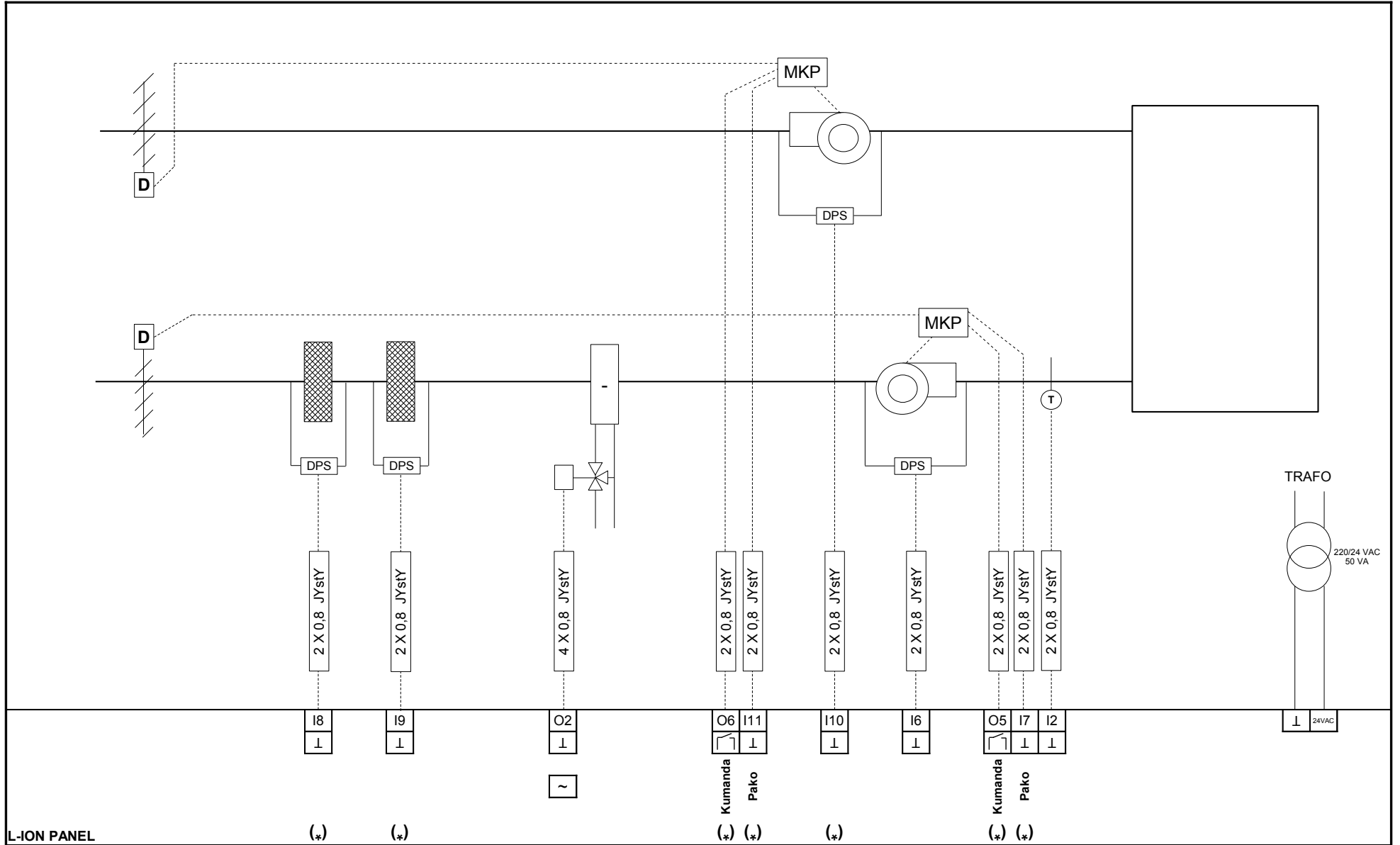

NOTLAR :

1-(*) İşaretili giriş/çıkışlar L-ION EP33 modelinde yoktur.

2-Röle çıkışlar 24VAC 5A'dır.



TEL: 0216 527 98 70
 FAX: 0216 527 98 71
 INTERNET: www.ontrol.com.tr

PROJE **ONTROL A.Ş**

SİSTEM **Senaryo Tip 36
 L-ION EP 44**

TARİH 03.09.2009
 REV.NO R01
 ÇİZEN AYSUN VAYIÇ